

M20x1,5 Kabelanschluss
 Cable connection
 Raccord de câbles

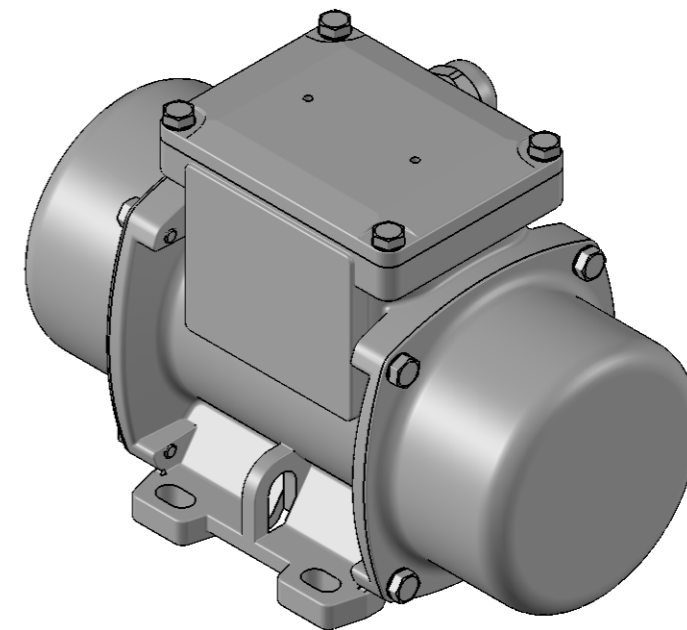
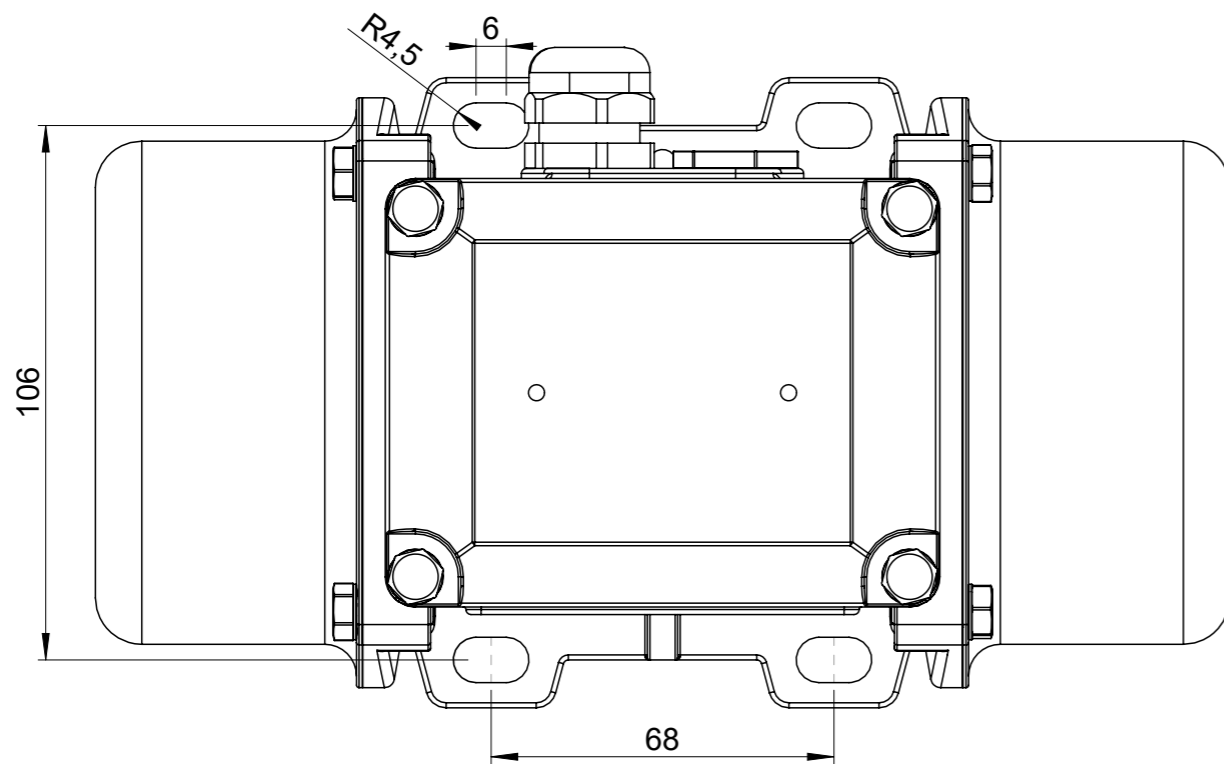
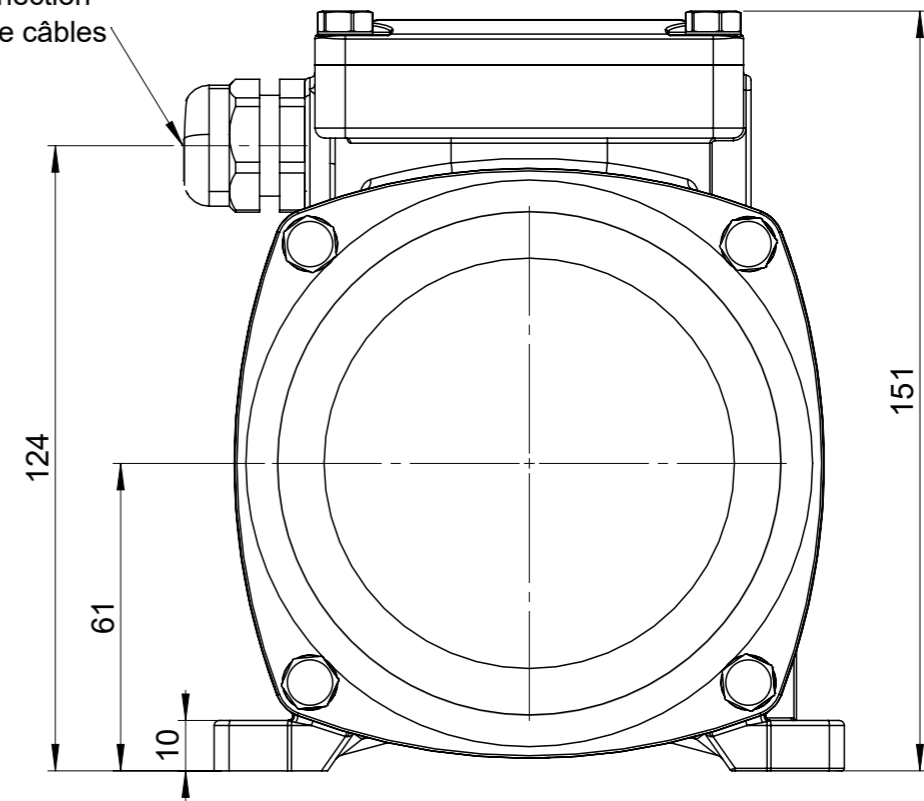

alle Schutzrechte vorbehalten
 all rights reserved
 tous droits réservés

Datum: / Date: / Date:
 15.01.2019

Angebot Nr.: / Quotation no.: / Offre no.:

Bestell Nr.: / Part no.: / No d'article:
 03020000

NES 2570

Elektro-Außenvibrator
 Electric external vibrator
 Vibrateur électrique externe

NetterVibration 
 Fritz-Ullmann-Straße 9, 55252 Mainz-Kastel
 Tel.: +49 6134 2901-0, www.NetterVibration.com