



NetterVibration

Operating instructions for
Direct Current Electric External
Vibrators
Series NED



August 2022
No. 2068E
Page 1/26

These operating instructions apply to:

NED 605
NED 5016
NED 50100
NED 50200

NED 50500
NED 601110
NED 601510



Contents

1	General information	3
2	Safety	5
3	Technical data	7
4	Design and function	9
5	Transport and storage	10
6	Installation	11
7	Start-up and operation	14
8	Maintenance and servicing	19
9	Troubleshooting	22
10	Spare parts and accessories	24
11	Disposal	25
12	Annex	26

Scope of delivery

Please refer to the delivery note for the scope of delivery.
Check the packaging for possible transport damage. In the event of damage to the packaging, check the contents for completeness and possible damage. Inform the carrier in the case of damage.

Designation

The Electric External Vibrators of the series NED are hereafter referred to as "NED".

Version of document

Document no.	2068E
Version no.	1
Date of issue	August 2022

1 General information

Use and storage	Before installing the NED read these instructions carefully. It is the basis for any action when dealing with the NED, and may be used for training purposes. The instructions should be subsequently stored at the operation site.
Target group	<p>The target group for these instructions is technical staff, who have basic knowledge in mechanics and electrics.</p> <p>Only complying technical staff may work on the NED.</p> <p>The NED may only be installed, put into operation, maintained, troubleshot and disassembled by persons authorised by the operator.</p>
Copyright	<p>This documentation is protected by copyright.</p> <p>NetterVibration reserves all rights such as translations, reprinting and reproduction of the instructions, as well as parts thereof.</p>
Limitation of liability	<p>All technical information, data and instructions for installation, operation and maintenance in these instructions are based on the latest information available at the time of printing and take our past experience to the best of our knowledge into account.</p> <p>No claims can be derived from the information, illustrations and descriptions in these operating instructions.</p> <p>The manufacturer does not assume liability for damages resulting from:</p> <ul style="list-style-type: none">• failure to observe the instructions,• improper use,• unauthorised repairs,• technical modifications,• use of non-permissible spare parts. <p>Translations are made to the best of our knowledge.</p> <p>NetterVibration does not assume liability for translation errors, even if the translation was made by us or on our behalf. Only the original German text remains binding.</p>
Directives / standards observed	<p>The Electric External Vibrators of the series NED comply with the electromagnetic compatibility directive 2014/30/EU.</p> <p>In particular the standards DIN EN 61000-6-2, DIN EN 61000-6-3 and DIN EN 61000-6-4 has been observed.</p>

Instruction and warning symbols

The following instruction and warning symbols are used in these instructions:

Personal injuries

⚠ DANGER	
	<p>indicates an immediate danger. Disregard of this notice will result in death or severe personal injuries.</p>

⚠ WARNING	
	<p>indicates a potential danger. Disregard of this notice can result in death or severe personal injuries.</p>

⚠ CAUTION	
	<p>indicates a potentially dangerous situation. Disregard of this notice can result in minor or moderate personal injuries.</p>

Material damages

NOTICE	
<p>indicates potential material damage. Disregard of this notice can result in material damage.</p>	

Notes

IMPORTANT	
<p>indicates actions, methods or notes that are not relative to safety, e.g. useful information and tips.</p>	

	<p>Environmentally safe disposal indicates the obligation of environmentally safe disposal.</p>
---	--

2 Safety

Intended use

The NED are intended for generating circular vibrations.

General applications are: loosening, conveying, sorting, compacting, separating bulk materials and reducing friction. NED are used for emptying bunkers, as drives for conveyor troughs, sieves and vibrating tables.

The NED are designed for installation in machines and may only be put into operation, if it has been assured that the complete machine complies with the regulations of the machinery directive.

Any other use is considered improper.

Qualification of qualified personnel

Installation, commissioning, maintenance and troubleshooting of the NED may only be performed by authorised qualified personnel.

All handling of the NED is the responsibility of the operator.

High voltage

⚠ DANGER	
	<p>Risk of electric shock due to high voltage</p> <p>An electric shock leads to serious injuries or even death.</p> <ul style="list-style-type: none"> ➤ Perform all work only with insulated tools suitable for the application. ➤ All work on the system may only be carried out in a volt-free state. ➤ Never open the terminal box cover when voltage is applied. ➤ Never loosen or remove paint-sealed screws. ➤ Never touch or remove safety covers. ➤ Protect the NED against falling parts during all work. Metal parts can cause a short circuit within the NED.

Safety rules

⚠ DANGER	
	<p>Electric shock</p> <p>An electric shock will result in serious injury or even death. The NED must be free of voltage during assembly, start-up, maintenance and troubleshooting.</p> <p>Observe the following five safety rules:</p> <ol style="list-style-type: none"> 1. Disconnect the NED from the mains supply. 2. Secure the NED against re-activation. 3. Establish that the NED has no voltage. 4. Earth and short-circuit the power supply of the NED. 5. Cover adjacent live parts or fence them off.

Falling parts

⚠ WARNING

Falling parts

The NED or parts of the construction can come loose due to vibration. Falling parts can lead to severe personal injuries.

- Use only suitable fastening screws and safety washer to attach the NED.
For attachment *NetterVibration* recommends using *Netter* fastening kits NBS.
- Check the fastening screws after one hour of operation and thereafter regularly (generally monthly).
- Retighten the fastening screws, if necessary. Use a torque wrench and tighten the screws crosswise.
- In critical installation situations suitable securing is mandatory.

Rotating Unbalances

⚠ WARNING

Risk of injury due to rotating unbalances

During operation of the NED without unbalance covers there is risk of injury due to rotating unbalances.

- Operate the NED only with mounted unbalance covers.

Heavy parts

⚠ WARNING

Risk of injury while handling heavy parts

Risk of serious injury due to weight during transport and installation of the NED.

- Observe the weight information in Chapter Technical data, from page 7 on.
- Only qualified personnel may transport and install the NED.
- Use suitable load handling devices and slinging equipment.
- Wear suitable personal protective equipment.

Hot surfaces

⚠ CAUTION

Risk of burns due to hot surfaces

NED can strongly heat up during operation. Direct contact may cause burns.



- Do not touch the NED or the cable near the cable gland during operation or shortly after being switched off.
- Only operate the vibrators within the permissible ambient temperature, according to Ch. Technical data, page 7.

3 Technical data

Permissible operating conditions	Nominal voltage, nominal frequency	<p>The main voltage must comply with the nominal voltage indicated on the type plate.</p> <p>Direct current 12 V or 24 V</p> <p>Permissible Voltage deviation:</p> <ul style="list-style-type: none"> • 12 V +/- 2 V • 24 V +/- 4 V <p>Changes of the unbalance settings influence the centrifugal force. During operation, the maximum permissible centrifugal force (according to the type plate) must not be exceeded. The compliance with the electromagnetic compatibility directive 2014/30/EU has to be ensured.</p>
	Rotary speed ranges	3000 min ⁻¹ or 3600 min ⁻¹
	Permissible ambient temperature*	<p>-20 °C to 40 °C</p> <p>The maximum ambient temperature specified on the type plate must not be exceeded. These values are valid for operation with an ON-period of 100 %. For the following operation modes special requirements apply:</p> <ul style="list-style-type: none"> • cycled operation or • synchronous operation. <p>These must be clarified with NetterVibration on a case-by-case basis.</p>
	Sound level	<p>Depending on type ≤ 70 dB(A)</p> <p>The sound level is determined to a great extent by the surface upon which the NED is mounted (e.g. sheet metal). The sound level will be amplified by non-silenced sheet metal.</p>



* Higher temperatures are only possible after consultation with and written approval from the application technicians of **NetterVibration**.

Type plate for NED 605 and NED 5016

 NetterVibration Germany, 55252 Mainz-Kastel Tel.: +49 (0) 6134 - 2901 - 0					
Type	1	I	5 A	Year	8
No.	2	P	6 W	Prot.	IP 9
Fc	3 N	U	7 VDC	Duty	10 %
n	4 min ⁻¹				

- 1 type designation
- 2 serial number
- 3 centrifugal force
- 4 rotary speed
- 5 current
- 6 power
- 7 nominal voltage
- 8 year of manufacture
- 9 degree of protection
- 10 duty cycle

Type plate

 Germany, 55252 Mainz-Kastel, Tel.: +49 6134 2901-0					
1	Type	 EN 60034-1	Duty	100 %	14
2	n min ⁻¹		Fc	N	13
3	U V		f	Hz	12
4	I A		P	kW	11
5	Ph		Cap.	µF	10
6	No.		Ins.Cl.	F	9
7	Year		Prot.	IP66	8

- 1 type designation
- 2 rotary speed
- 3 nominal voltage
- 4 current
- 5 phases / capacity
- 6 serial number
- 7 year of manufacture
- 8 degree of protection
- 9 insulation class
- 10 power factor
- 11 power
- 12 nominal frequency
- 13 centrifugal force
- 14 duty cycle

The values can be found on the type plate. The type plate is located on the housing. For detailed technical data please refer to the brochure of the NED. Deviating customer-specific type plates (special designs) are possible.

Tightening torques

NetterVibration recommends the following tightening torques [Nm]:

Type	M4	M5	M6	M8	M10	M12	M16	M20	M22	M24
Fastening screws and nuts, steel Property class 8.8*	-	-	10	25	50	87	210	411	559	711
Fastening screws for XS-unbalances, steel Property class 12.9**	-	-	-	42	83	146	360	710	970	1225
Fastening screws and nuts, stainless steel			8.8	21.4	44	74	183	-	-	-
Terminal plate nuts, steel	1.2	2.0	3.0	6.5	13.5	-	-	-	-	-

Screws as supplied, without additional lubrication.

** coefficient of sliding friction 0.14*

*** coefficient of sliding friction 0.15*

Always use a torque wrench and tighten the screws crosswise.

Type	M13x1	M15x1	M20x1	M25x1.5	M30x2	M45x1.5
Locking nuts (Pos. 21) see page 20.	30	50	100	170	340	500

4 Design and function

Design

Example: NED 50100

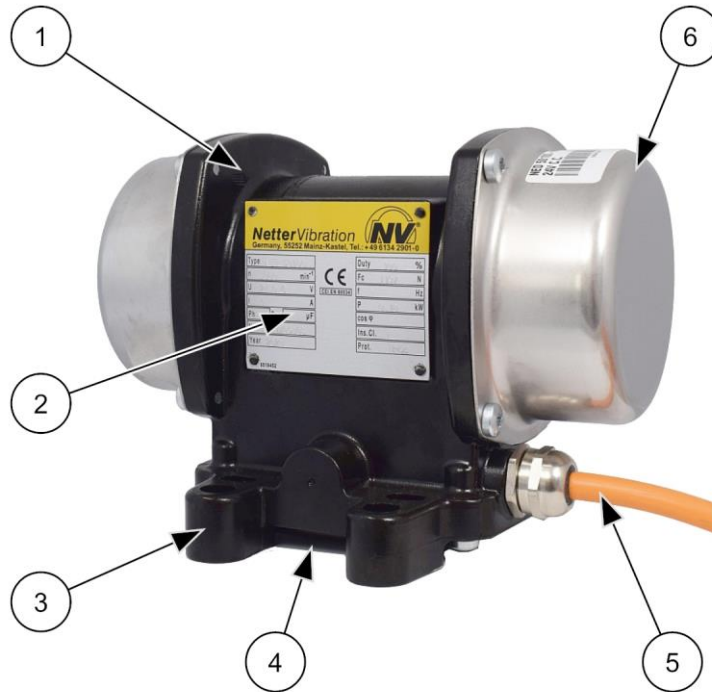

No.	Element	Function
1	Housing	Contains and protects the components of the NED.
2	Type plate	Shows model specific information and data.
3	Housing foot	Attach the NED to the mounting surface.
4	Terminal box (Here on the bottom side. Position depending on type.)	Includes electrical parts.
5	Connection cable	Connecting the NED to the customer's power supply.
6	Unbalance covers	Protect against grabbing into the unbalances.

Function

The Electric External Vibrators of the series NED are direct current motors/ asynchronous motors with inverter, with adjustable weights (unbalances) mounted on their shaft ends.

The NED generate circular vibrations, that means the vibrations act in all directions of a plane.

The centrifugal force can be changed by adjustment of the unbalances.

5 Transport and storage



Observe the safety instructions in Ch. Safety, from page 5 on.

Please refer to the brochure for weights and dimensions.

Transport-conditions

When transporting the NED, ensure that the NED is not subjected to strong impacts or vibrations that could damage the bearings.

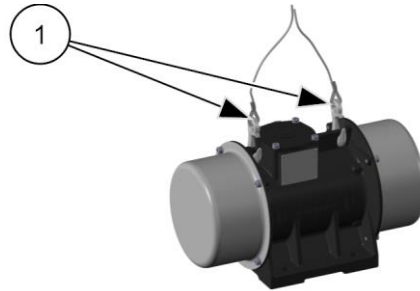

Please observe the following notes:

- Use only the transport eyelet/eyelets (1) for lifting the NED. If the vibrator is fitted with two transport eyes, both must be used for lifting.
- The pulling direction must not exceed 45°.
- Lifting tools are of the usual kind such as a pulley or a crane. When moving loads, use suitable steel cables or hoisting slings which are sufficiently dimensioned for these weights.
- Handle the NED very carefully during transport.

Packaging

The NED are packed ready for installation.

The packaging protects the NED from transport damage. The packaging material has been selected from an environmentally safe and technically disposable point of view and is therefore recyclable.

The return of packaging to the material cycle conserves raw materials and reduces the amount of waste.

Storage

- Store the NED in a dry and clean environment.
- The permissible storage temperature is between -15 °C and +60 °C.
- The permissible relative humidity is max. 60 %.
- The storage time is max. 2 years.
- Do not store the NED outdoors. The electrical components are not protected against corrosion.

6 Installation



Observe the safety instructions in Ch. Safety, from page 5 on.

Please refer to the brochure for weights and dimensions.

Fastening the NED

The NED can be operated in any position.

1. **Notice:** The feet of the NED must lie completely on the surface so that there is no tension in the housing when tightening the fastening screw/screws, which could cause mechanical damage. The mounting surface has to be flat (± 0.1 mm flatness) and clean with no paint residues or burn-ins.



2. The vibrators can be fastened with fastening screws of quality 8.8 (DIN 931 or 933). These must be secured with appropriate locking devices and checked and retightened at regular intervals (usually monthly). For safe fastening **NetterVibration** recommends the use of fastening kits NBS consisting of a screw, a special lock washer and (for NBS D) a nut.

Fasten the NED with the fastening screws on the mounting surface. Use a torque wrench and tighten the screws crosswise. Observe the recommended values for screw sizes and tightening torques, see chap. Technical data, from page 7. Higher tightening torques may cause fracture of screws or tearing of threads.

Warning: Unsuitable screw connections may cause loosening of the NED by vibration. This can cause damage to persons and material.

3. Use an additional safety device for critical installation situations, e.g. steel cable NSE. Use the wire cable clamps to set the safety cable to the shortest possible cable length. The safety cable must always be tensioned.



Electrical connection

The following requirements and conditions must be met to connect the NED electrically:

- The electrical connection may only be carried out by authorised, qualified personnel.
- All work must be carried out exclusively with insulated tools suitable for the application.
- The permissible operating conditions must be met. Please refer to chap. Technical data, page 7 for operating conditions.
- The supply voltage must correspond to the information on the type plate.
- The permissible deviation of the supply voltage must be observed, see chap. Technical data, page 7.
- For the models NED 50100 up to NED 601510:
It is imperative to pay attention to the correct polarity, because the NED will not start if the polarity is wrong.

- A suitable overload protection (1) must be pre-connected to each vibrator. The motor protection switches must be interlocked with each other in pairs, so that in the event of a motor failure, the power supply from both motors is interrupted at the same time in order not to cause uncontrolled vibrations which can damage the system.

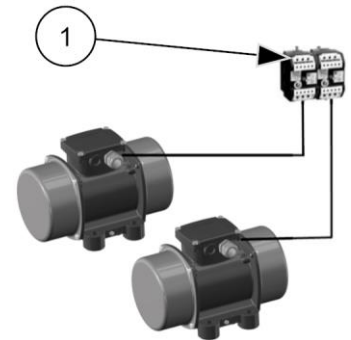

- All electrical cables must be carefully laid and must be protected from high temperatures, lubricants and sharp edges. Care must be taken to ensure that the cables are not chafed through by vibrating parts. The correct condition of the electrical cables with their plugs must be checked at regular intervals (usually every six months). Detected errors are to be eliminated immediately.

- The wire ends must be fitted with suitable insulated cable lugs, in order to prevent the strands from splaying.



Note that the models NED 50100 up to NED 601510 have a start delay of approx. 1 second.

Connection examples NED

Connect the NED via the supplied cable according to the specifications on the type plate.

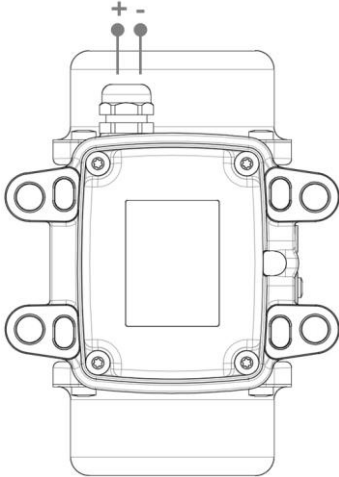
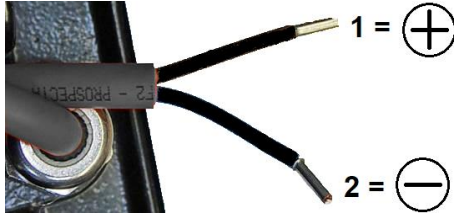
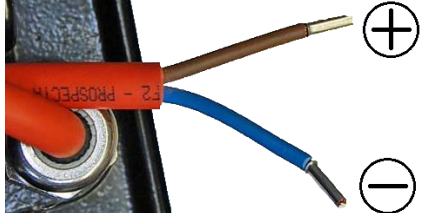
<p>Polarity of the connection cables:</p> 	<p>NED Models: 605, 5016. The insulation is marked with the numbers 1 or 2.</p> 
	<p>NED Models: 50100, 50200, 601110, 601510. Brown cable + Blue cable -</p> 

7 Start-up and operation



Observe the safety instructions in chap. Safety, from page 5 on.

Permissible operating conditions

Please refer to chap. Technical data, page 7 for permissible operating conditions.

Regulations

- When commissioning the NED, the rules and regulations of the local associations for electrical engineering (e.g. VDE) and the valid accident prevention regulations must be observed.
- The NED must always be switched on and off at the main switch.
- The NED must not be operated without the covers for the unbalances. The rotating unbalances cause a risk of injury.
- On initial start-up, the current consumption must be measured and must correspond to the specifications on the type plate.
- The terminal box cover must never be opened in the presence of voltage.

Note that the models NED 50100 up to NED 601510 have a start delay of approx. 1 second

Measures

Carry out the following measures before start-up:

1. Check that the NED have been mounted correctly and are in perfect condition.
2. Check that the NED have been properly connected.
3. Check that the cables are undamaged and laid according to the known regulations and standards.
4. Check that all permissible operating conditions have been observed.
5. Check that all protective measures on the system have been observed.
6. Eliminate possible errors before start-up.
7. Screw connections must be checked and, if necessary, retightened after 1 h operating time (after initial start-up) and thereafter regularly (generally monthly). Observe the recommended values for screw sizes and tightening torques, see chap. Technical data, from page 7.

Adjustment of unbalances

For all NED there is the possibility of unbalance adjustment to directly influence vibration amplitude, centrifugal force and current consumption. Unless otherwise specified by you, the NED were delivered with the standard setting (100 %). If specifications have been made by the customer, there are stickers with the current setting on the unbalance covers.

Notice: The unbalances may only be set mirror-symmetrically!

**Procedure:**

1. Switch off the NED at the main switch, secure against unintentional starting and ensure that there is no voltage.
2. Loosen both unbalance covers.
3. Loosen the locking nuts or locking screws.
4. Bring the unbalances to the desired setting according to the following descriptions for the various unbalance discs. Note the mirror-symmetrical setting.
5. Retighten the locking nuts or locking screws. Observe the recommended tightening torques, see chap. Technical data, from page 7
6. Fasten both covers for the unbalances.

* For NED 5016: The two unbalance covers can be unscrewed using an oil filter/strap wrench.

Settings:

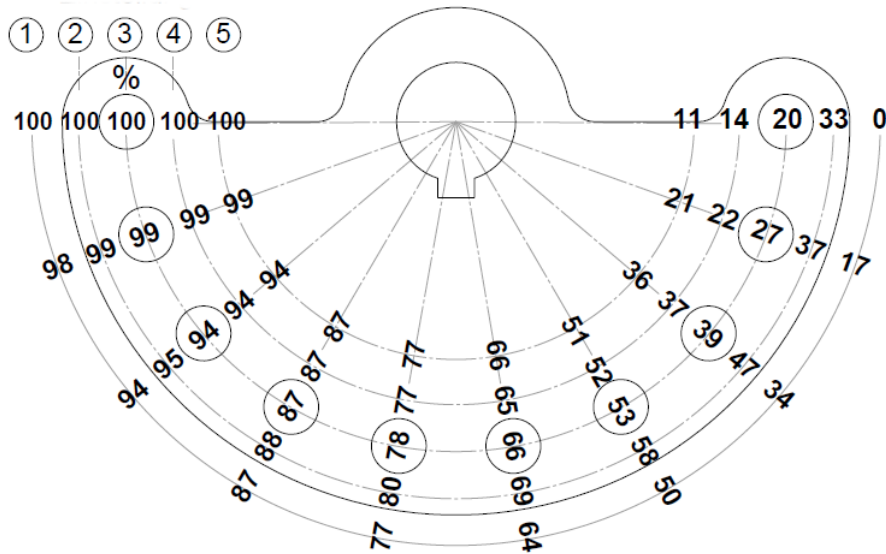

Type	Settings	Number of unbalances	Unbalance per side	
			fixed	adjustable
NED 50100	2	6	2	1
NED 50200	3	10	3	2
NED 50500	3	10	3	2
NED 601110	1	8	2	2

Example:

NED 50100 has a total of 6 unbalance discs (3 discs per side: 2 fixed, 1 adjustable).

If a centrifugal force of 88% is desired, the adjustable unbalance discs are rotated anticlockwise on both sides into the fourth grid position.

centrifugal force 100 %



centrifugal force 88 %



**Unbalances
type XN**

The centrifugal force of the NED 601510 is adjustable with the unbalance discs type XN.

To adjust the unbalance, loosen the bolts with nuts on the unbalances on both sides. By turning the unbalance disc/ discs to another position, the percentage value of the centrifugal force changes according to the following figure.

After adjustment, fasten the bolts with nuts on both sides, with the recommended torque, see page 8.

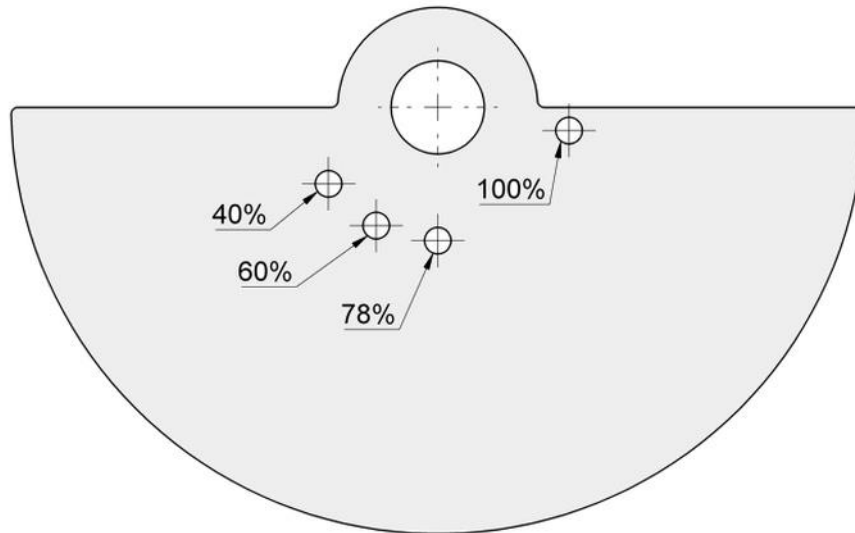

8 Maintenance and servicing



Observe the safety instructions in chap. Safety, from page 5 on.

Technical data Information regarding tightening torques for screws and nuts can be found in Ch. Technical data, page 7.

Expertise and regulations Maintenance and servicing of the vibrators may only be performed by regularly trained, authorised and qualified personnel. Work on the electrical system may only be carried out by a qualified electrician.
The qualified personnel has to work exclusively with tools suitable for the application.

In the case of unauthorised intervention in the NED there is no longer any warranty claim.

Before all maintenance and servicing work the NED must be safely disconnected from the electrical mains. The procedure is as follows:

1. Switch off NED.
2. Secure against unintentional switching on.
3. Determine that NED are voltage free.
4. Earth and short-circuit.
5. Cover and fence off neighbouring live parts.

Maintenance plan

Maintenance of the NED must be carried out as follows:

Interval	Action
If required (depending on operating conditions)	Clean the NED regularly with a wet cloth to remove dust deposits.
After one hour operation after initial start-up	Check screw connections and retighten if necessary.
Monthly	Check screw connections and retighten if necessary.
	Check bearing for irregular bearing noise. Replace damaged bearings or bearings whose service life has been reached.
	Check cable supply line.
Every 6 month	Check proper condition of connecting cables and plugs.
Every 2 years	Replace O-rings and plastic seals.
At least every 4 years	Check proper condition of electrical systems and stationary electrical equipment.
When the bearing life is reached	Replace the bearings and replace them with equivalent bearings.

Other maintenance and repair work are to be carried out exclusively by **NetterVibration**.

Service life / bearing life

Depending on the operating conditions, the wear of the installed carbon brushes determines the service life of the types NED 605 und 5016. The carbon brushes can not be replaced.

Depending on the operating conditions, the bearing life determines the service life of the types NED 50100, 50200, 50500, 601110, 601510. When the bearing service life is reached, replace the bearings with equivalent ones, see section " Replacement of bearings".

Type	Service life [h]	Bearing life [h]
NED 605	1500	-
NED 5016	3000	-
NED 50100	-	20230
NED 50200	-	3844
NED 50500	-	1378
NED 601110	-	2092
NED 601510	-	858

Replacement of bearings

The item numbers refer to the spare parts list.

Example: NED 50100

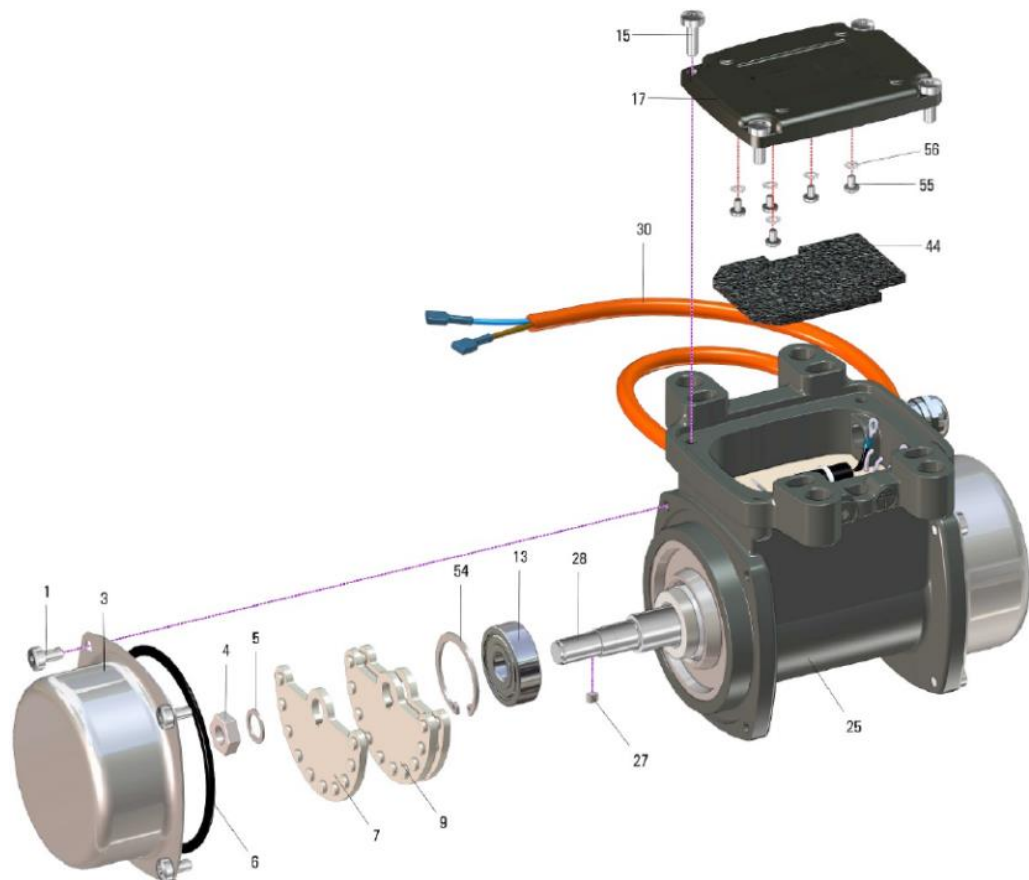

1. Switch off NED, secure against switching on again and ensure that it is volt-free.
2. Loosen screw (1) and remove unbalance covers (3).

3. **Disassemble unbalances type XL and type XLs:**

Screw a long screw with the same thread into a tapped hole for the fastening screws (1) of the unbalance cover. Put a lever between the unbalance discs and this long screw. After loosening the locking nut (4), the unbalances can be removed from the shaft.

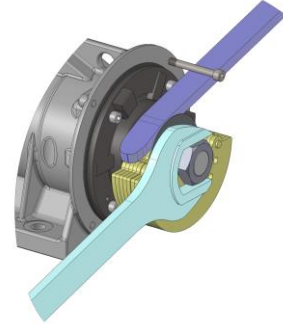

4. Remove circlip (54).
5. Replace both bearings (13) with equivalent bearings.
6. Assembly is carried out in the reverse order.
7. Tighten locking nuts (4) to the specified tightening torque.
8. Before mounting the unbalance covers, replace the seals (5) with equivalent seals and check for correct fit.
9. Mount unbalance covers.

9 Troubleshooting



Observe the safety instructions in chap. Safety, from page 5 on.

Expertise and regulations

Troubleshooting of the vibrators may only be performed by regularly trained, authorised and qualified personnel. Work on the electrical system may only be carried out by a qualified electrician.

The qualified personnel has to work exclusively with tools suitable for the application.

In the case of unauthorised intervention in the NED there is no longer any warranty claim.

Before any troubleshooting the NED must be safely disconnected from the electrical mains. The procedure is as follows:

1. Switch off NED.
2. Secure against unintentional switching on.
3. Determine that NED are voltage free.
4. Earth and short-circuit.
5. Cover and fence off neighbouring live parts.

Trouble-shooting

Fault	Possible cause	Corrective action
Vibrator does not start or runs at too low speed	For NED 605 and NED 5016: carbon brushes worn.	Replace vibrator.
	Mains voltage too low	Check mains voltage and cable cross-section and, if necessary, adjust or replace cable.
	Mains voltage too high. This damages the inverter board.	Replace the inverter board. Contact NetterVibration .
	Connection with incorrect polarity.	Observe/correct polarity.
Vibrator speed drops under load	For NED 605 and NED 5016: carbon brushes worn.	Replace vibrator.
	Faulty contact of a connection point in the terminal box	Check connections/connection points in the terminal box and correct faulty connections/connection points.
	Defective contact of a connection point	Check connections in the terminal box, tighten terminal plate nuts.
	Cable breakage	Check connection cable, replace if necessary.
	Incorrectly dimensioned connection cable	Check cable cross section and replace cable, if necessary.
	Overload	Check setting of unbalance, reduce unbalances.
	Mains voltage too low	Check mains voltage and cable cross-section and, if necessary, adjust or replace cable.
Excessive heating of the vibrator	See fault "High current consumption".	
Circuit breaker fails when switched on	Phase interruption	Check fuse and connection cable, replace, if necessary.
	Overload	Check unbalance settings, reduce unbalance.
	Short circuit in winding	Replace vibrator.
High current consumption	For NED 605 and NED 5016: carbon brushes worn.	Replace vibrator.
	Bearings worn	Replace bearings.
	Natural resonance range of vibration system	Measure current consumption, stiffen device.
	Bounce impacts	Measure current consumption, reduce power of vibrator.
Check fastening, tighten fastening screws, if necessary.		

10 Spare parts and accessories

Ordering of spare parts

Please provide the following details when ordering spare parts:

1. type designation according to the type plate
2. serial number according to the type plate
3. description and position number of spare part, according to the overview on page 20
4. required amount

Accessories

The following accessories are available for NED:

Component	Description
Shim washers	Compensation for removed unbalance discs.
Fastening kit NBS	Recommended for secure and permanent fastening of the NED.

Further electrotechnical accessories on request.

Special versions

Customised special versions are available on request.
Contact **NetterVibration**.

11 Disposal

Prices

	<p>All parts of the NED must be properly disposed of according to the material specifications. The valid disposal prices of the NED are available on request.</p>
---	---

Material-specifications

All parts of the NED can be recycled.

Material	Part
Steel or stainless steel	Rotor, unbalances, flange, bearings, screws, washers, nuts, unbalance covers
Aluminium	Housing, type plate
Plastic	Seals, terminal box block, sheathing of connection cable and strands
Copper, copper with resin	Strands of the connection cable, winding

12 Annex

The declaration of conformity can be found at: [www.**NetterVibration**.com](http://www.NetterVibration.com)