



NetterVibration



Operating instructions for
electric external vibrators
series NEA/NEG/NEG S/NES/CIN

July 2025
No. 1929E
Page 1/45

These operating instructions apply to: **Series NEA**
Series NEG
Series NEG S
Series NES
Series CIN

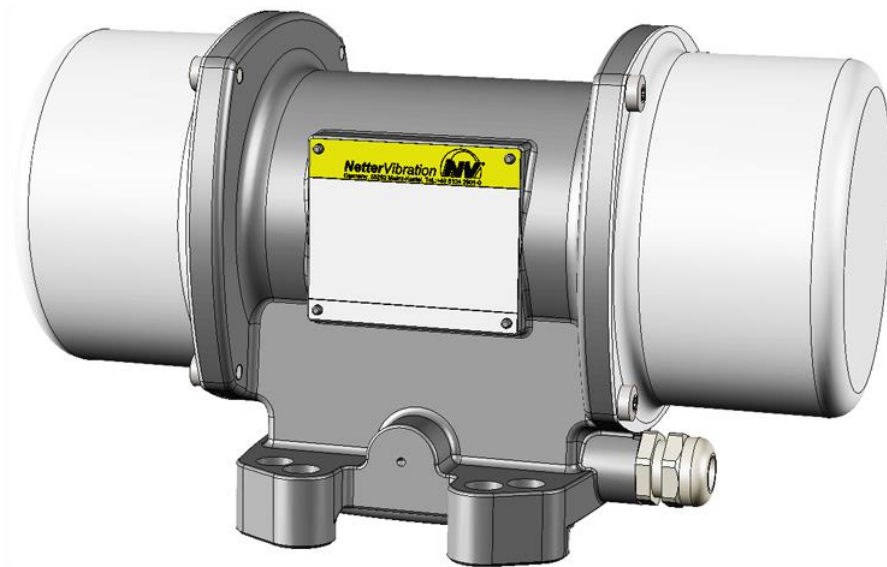
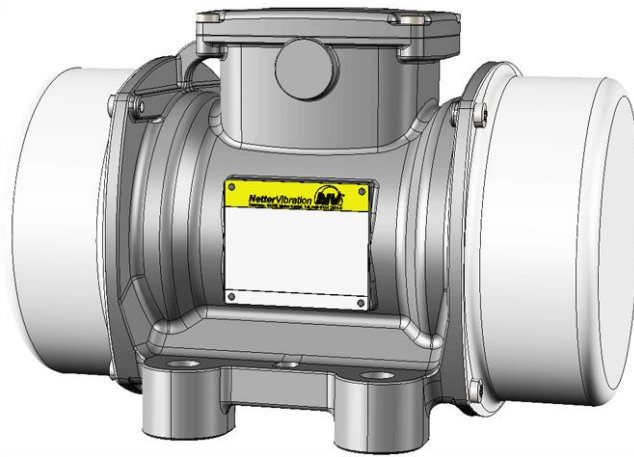

Contents

1	General information	3
2	Safety	6
3	Technical data	12
4	Design and function	15
5	Transport and storage	16
6	Installation	17
7	Start-up and operation	21
8	Maintenance and servicing	28
9	Troubleshooting	33
10	Spare parts and accessories	35
11	Disposal	37
12	Annex	38

Scope of delivery

Please refer to the delivery note for the scope of delivery.
Check the packaging for possible transport damage. In the event of damage to the packaging, check the contents for completeness and possible damage. Inform the carrier in the case of damage.

Designation

The electric external vibrators of the series NEA, NEG, NEG S, NES and CIN are hereafter referred to as "NEA/NEG".

Version of document

Document no.	1929E
Version no.	5
Date of issue	July 2025

1 General information

Use and storage	Before installing the NEA/NEG read these instructions carefully. It is the basis for any action when dealing with the NEA/NEG, and may be used for training purposes. The instructions should be subsequently stored at the operation site.
Target group	The target group for these instructions is technical staff, who have basic knowledge of mechanics, electrics and explosion protection. Only complying technical staff may work on the NEA/NEG. The NEA/NEG may only be installed, put into operation, maintained, troubleshoot and disassembled by persons authorised by the operator.
Copyright	This documentation is protected by copyright. NetterVibration reserves all rights such as translations, reprinting and reproduction of the instructions, as well as parts thereof.
Limitation of liability	All technical information, data and instructions for installation, operation and maintenance in these instructions are based on the latest information available at the time of printing and take our past experience to the best of our knowledge into account. No claims can be derived from the information, illustrations and descriptions in these operating instructions. The manufacturer does not assume liability for damages resulting from: <ul style="list-style-type: none">• failure to observe the instructions,• improper use,• unauthorised repairs,• technical modifications,• use of non-permissible spare parts. Translations are made to the best of our knowledge. NetterVibration does not assume liability for translation errors, even if the translation was made by us or on our behalf. Only the original German text remains binding.
Directives observed	The electric external vibrators of the series NEA, NEG, NEG S, NES and CIN comply with the following directives: <ul style="list-style-type: none">• EC Machinery Directive 2006/42/EC,• Supply of Machinery (Safety) Regulations 2008 (UK),• Electromagnetic Compatibility Directive 2014/30/EU,• Electromagnetic Compatibility Regulations 2016 (UK),• Low Voltage Directive 2014/35/EU,• Electrical Equipment (Safety) Regulations 2016 (UK).

 All electric external vibrators of the series NEA/NEG, labelled with the Ex-Symbol on the type plate, comply with the following directives:

- ATEX directive 2014/34 EU for equipment group II,
- Equipment and Protective Systems Intended for use in Potentially Explosive Atmospheres Regulations 2016 for equipment group II (UK).

NEA/NEG of housing size 50 and 60 with ATEX labelling on the type plate are suitable for use in potentially explosive areas of the category 3D in the zone 22.

NEA/NEG from housing size 100 upwards with ATEX labelling on the type plate are suitable for use in potentially explosive areas of the category 2D in the zone 21 and 22.



The main standards observed are indicated in the declaration of conformity.

Before using the NEA/NEG the operator must exclude the possibility that the introduction of vibrational energy poses the risk of explosion.

The following instruction and warning symbols are used in these instructions:

Instruction and warning symbols

Personal injuries



⚠ DANGER	
	<p>indicates an immediate danger. Disregard of this notice will result in death or severe personal injuries.</p>
⚠ WARNING	
	<p>indicates a potential danger. Disregard of this notice can result in death or severe personal injuries.</p>
⚠ CAUTION	
	<p>indicates a potentially dangerous situation. Disregard of this notice can result in minor or moderate personal injuries.</p>

Material damages

NOTICE	
<p>indicates potential material damage. Disregard of this notice can result in material damage.</p>	

Notes

IMPORTANT	
<p>indicates actions, methods or notes that are not relative to safety, e.g. useful information and tips.</p>	

	<p>Environmentally safe disposal indicates the obligation of environmentally safe disposal.</p>
	<p>Explosion prevention indicates information on explosion prevention.</p>

ATEX-notes

When operating the NEA/NEG in potentially explosive areas all notes, marked with the Ex-symbol , must be observed.

Type designations

Explanations of abbreviations in the type designation:
XXX YYZZZZ-WWW

XXX indicates the type of vibrator (three-phase or single-phase):

- **NEA** = single-phase alternating current
- **NEG** = 3-phase alternating current
- **NES** = 3-phase alternating current (stainless steel housing)
- **CIN** = 3-phase alternating current

YY indicates the polarity:

- **50** = 2 poles
- **25** = 4 poles
- **16** = 6 poles
- **12** = 8 poles

ZZZZ indicates the centrifugal force in daN (Decanewton).

WWW indicates special features:

- **K** = 130 °C PTC thermistor installed (standard from housing size 170 upwards)
- **K2** = 120 °C PTC thermistor installed
- **TS** = 130 °C thermal protector with a normally closed (NC) switching contact
- **TS2** = 120 °C thermal protector with a normally closed (NC) switching contact
- **H** = 200 - 240 V anti-condensation heater 0 - 50 W
- **H110** = 100 - 120 V anti-condensation heater 0 - 50 W
- **HD** = Fully encapsulated stator (heavy duty)

Suffix **S** behind the type designation = stainless steel housing

2 Safety

Intended use

The NEA/NEG are intended for generating circular vibrations. General applications are: loosening, conveying, sorting, compacting, separating bulk materials and reducing friction. NEA/NEG are used for emptying bunkers, as drives for conveyor troughs, sieves and vibrating tables.

The NEA/NEG are designed for installation in machines and may only be put into operation, if it has been assured that the complete machine complies with the regulations of the machinery directive.

Any other use is considered improper.

Qualification of qualified personnel

Installation, commissioning, maintenance and troubleshooting of the NEA/NEG may only be performed by authorised qualified personnel, who have basic knowledge of mechanics, electrics and explosion protection.

All handling of the NEA/NEG is the responsibility of the operator.

Accessory parts

 All accessory parts connected to the NEA/NEG, which ensure correct operation and safety, must have the appropriate degree of protection for this specific purpose.

Liability

IMPORTANT
NetterVibration assumes no liability for personal injuries and material damages if technical changes to the product were made or the notices and regulations in these instructions were not observed.

Safety rules

 DANGER
<p>Electric shock</p> <p>An electric shock will result in serious injury or even death. The NEA/NEG must be free of voltage during assembly, start-up, maintenance and troubleshooting.</p> <p>Observe the following five safety rules:</p> <ol style="list-style-type: none"> 1. Disconnect the NEA/NEG from the mains supply. 2. Secure the NEA/NEG against re-activation. 3. Establish that the NEA/NEG has no voltage. 4. Earth and short-circuit the power supply of the NEA/NEG. 5. Cover adjacent live parts or fence them off.

High voltage

⚠ DANGER	
Risk of electric shock due to high voltage	
An electric shock leads to serious injuries or even death.	
<ul style="list-style-type: none"> ➤ Observe the permissible protection class and earthing. The NEA/NEG may only be operated with the correct connection of the protective conductor. ➤ Perform all work only with insulated tools suitable for the application. ➤ All work on the system may only be carried out in a volt-free state. ➤ Never open the terminal box cover when voltage is applied. ➤ Never loosen or remove paint-sealed screws. ➤ Never touch or remove safety covers. ➤ Protect the NEA/NEG against falling parts during all work. Metal parts can cause a short circuit within the NEA/NEG. 	



Spark formation

⚠ WARNING	
	<p>Spark formation</p> <p>Opening the terminal box cover of the NEA/NEG in Ex-zones can cause spark formation and thus lead to an explosion due to ignition of an explosive atmosphere.</p> <ul style="list-style-type: none"> ➤ Never open terminal box covers in a potentially explosive atmosphere or when voltage is applied. ➤ If terminal box covers or unbalance covers are open, check the condition and correct positioning of the seals. ➤ Damaged seals must be replaced immediately. ➤ The mechanical protection of the housing (IP65 or IP66) must be assured after assembly of the covers.

Spark formation

⚠ WARNING	
	<p>Spark formation</p> <p>The impact of corroded steel parts on the aluminium housing at high speed can cause spark formation and thus lead to an explosion.</p> <ul style="list-style-type: none"> ➤ Choose the installation position carefully, so that there are no external impacts. ➤ Fasten the NEA/NEG securely. ➤ Check the fastening regularly (generally monthly).

Static electricity

⚠ WARNING	
	<p>Hazard of electrostatic discharge</p> <p>When cleaning the NEA/NEG with a dry cloth there is a risk of electrostatic discharge. A electrostatic discharge can lead to an explosion due to ignition of an explosive atmosphere.</p> <ul style="list-style-type: none"> ➤ Only clean the NEA/NEG with a wet cloth. ➤ Remove dust deposits regularly. ➤ From housing size 100 onwards, the following warning sticker is located on the NEA/NEG and must be observed: <div style="border: 1px solid black; padding: 5px; margin: 10px 0;"> <p style="text-align: right; font-size: small;">0518437</p> <p style="text-align: center;">ACHTUNG  WARNING</p> <p style="font-size: x-small;">Nicht öffnen in explosionsfähiger Atmosphäre. Gefahr durch elektrostatische Aufladung. Nur mit feuchtem Tuch reinigen.</p> <p style="font-size: x-small;">Do not open when an explosive atmosphere is present. Potential electrostatic charging hazard. Clean only with a wet cloth.</p> </div>

Static electricity

⚠ WARNING	
	<p>Static electricity</p> <p>The discharge of charged, isolated conductive parts can cause ignitable sparks.</p> <ul style="list-style-type: none"> ➤ Connect the green-yellow protective conductor only to the earth terminal in the terminal box. ➤ Connect the earthing screw of the NEA/NEG to the potential equalisation of the higher-level machine. ➤ Include all components in the potential equalisation of the machine.

Hot surface

⚠ WARNING	
	<p>Hot surface</p> <p>If the permissible operating conditions and the maintenance requirements are not observed or if the vibrator does not fit the application, the housing surface may become very hot. In Ex-zones there is a risk of ignition of an explosive atmosphere due to hot surfaces.</p> <ul style="list-style-type: none"> ➤ Observe all permissible operating conditions. ➤ Carry out the specified maintenance work at the pre-defined intervals. ➤ Make sure that the vibrator is suitable for the application and has been dimensioned correctly. Get advice from application technicians of NetterVibration. ➤ For operating the NEA/NEG in potentially explosive atmosphere, it is mandatory to connect the PTC-thermistor. This regulation does not apply if the vibrator is not equipped with a PTC-thermistor.

NEA/NEG from housing size 170 upwards are equipped with thermistors type PTC 130 °C as standard.

Frequency and unbalance settings

⚠ WARNING	
<p>Risk of injury and machine damage due to incorrect frequency and unbalance settings</p> <p>There is a risk of serious bodily injury due to uncontrolled machine movements. Incorrect frequency and unbalance settings on the vibrators can cause severe damage to the vibrators as well as the machine.</p> <ul style="list-style-type: none"> ➤ The vibrators may only be operated with the maximum permissible frequency/unbalance combination. ➤ When changing the frequency and unbalance settings of the vibrators, observe the information on the type plate as well as the table for frequency/unbalance setting on page 22. ➤ Switch off the NEA/NEG immediately if you notice any irregularities in its operation. Eliminate the fault before switching on again. 	

Heavy parts

⚠ WARNING	
	<p>Risk of injury while handling heavy parts Risk of serious injury due to weight during transport and installation of the NEA/NEG.</p> <ul style="list-style-type: none"> ➤ Observe the weight specifications in the brochure of the vibrators. ➤ Only qualified personnel may transport and install the NEA/NEG. ➤ Use suitable load handling devices and slinging equipment. ➤ Wear suitable personal protective equipment.

Falling parts

⚠ WARNING	
	<p>Falling parts The NEA/NEG or parts of the construction can come loose due to vibration. Falling parts can lead to severe personal injuries.</p> <ul style="list-style-type: none"> ➤ Use only suitable fastening screws and safety washer to attach the NEA/NEG. For attachment NetterVibration recommends using fastening kits NBS. ➤ Check the fastening screws after one hour of operation and thereafter regularly (generally monthly). ➤ Retighten the fastening screws, if necessary. Use a torque wrench and tighten the screws crosswise. ➤ In critical installation situations suitable securing is mandatory.

Rotating Unbalances

⚠ WARNING	
	<p>Risk of injury due to rotating unbalances During operation of the NEA/NEG without unbalance covers there is risk of injury due to rotating unbalances.</p> <ul style="list-style-type: none"> ➤ Operate the NEA/NEG only with mounted unbalance covers.

Hot surfaces

⚠ CAUTION	
	<p>Risk of burns due to hot surfaces NEA/NEG can strongly heat up during operation. Direct contact may cause burns.</p> <ul style="list-style-type: none"> ➤ Do not touch the NEA/NEG or the cable near the cable gland during operation or shortly after being switched off. ➤ Only operate the vibrators within the permissible ambient temperature, according to chap. Technical data, starting on page 12.

Special conditions

 **For the operation of the NEA/NEG in ATEX zones, the following conditions for safe use must be met:**



- When operating with a frequency converter in ATEX zones, the vibrator must be equipped with a PTC thermistor. The PTC thermistor must be connected and evaluated by the operator. The temperature of 130 °C must not be exceeded.
- A 130 °C PTC thermistor is installed from housing size 170 included and up. The connection of this protection is mandatory for the user.
- All safety devices shall operate independently of any measurement or control devices required for operation, and comply with the EN 50495. Resetting the safety devices shall only be manual.
- Potential electrostatic charging hazard. Clean only with a wet cloth.
- Opening the terminal box cover is not permitted if an explosive atmosphere is present.
- Ambient temperature range: -20 °C ... +40 °C/+55 °C.
- The entries of the equipment shall be equipped with certified cable glands or blanking elements with compatible modes of protection for the intended use.

The cables and the relevant accessories (e.g. cable glands) must be suitable for an operating temperature at least:

- +85 °C up to housing size 130 for an ambient temperature of +40 °C (excepted the motors with 8 poles).
- +90 °C up to housing size 130 for an ambient temperature of +40 °C (only the motors with 8 poles).
- +100 °C up to housing size 130 for an ambient temperature of +55 °C.
- +105 °C for housing size 133 and up for an ambient temperature of +40 °C.
- +120 °C for housing size 133 and up for an ambient temperature of +55 °C.

3 Technical data

Permissible operating conditions

ATEX zones	<p> Only vibrators with an ATEX marking on the rating plate may be used in ATEX zones.</p>
Nominal voltage, nominal frequency	<p>The main voltage and the main frequency must comply with the nominal voltage and nominal frequency indicated on the type plate. Permissible Voltage deviation: $\pm 5\%$ Permissible frequency deviation: $\pm 2\%$</p> <p>Possible power supply with:</p> <ul style="list-style-type: none"> • fixed voltage and frequency or • frequency converter <p>Frequency changes and unbalance settings influence the centrifugal force. During operation, the maximum permissible centrifugal force (according to the type plate) must not be exceeded. The compliance with the electromagnetic compatibility directive 2014/30/EU has to be ensured.</p> <p> In the ATEX-zones 21 and 22 the frequency converter may regulate the frequency between 20 Hz and 50 Hz or 20 Hz and 60 Hz at a constant torque load (linear volt-hertz-curve). Please observe the max. frequency on the type plate. For operation with frequency converter in ATEX-zones the PTC thermistor must be connected.</p>
Rotary speed ranges	<p>2-pole: 3000 min⁻¹ 50 Hz / 3600 min⁻¹ 60 Hz. 4-pole: 1500 min⁻¹ 50 Hz / 1800 min⁻¹ 60 Hz. 6-pole: 1000 min⁻¹ 50 Hz / 1200 min⁻¹ 60 Hz. 8-pole: 750 min⁻¹ 50 Hz / 900 min⁻¹ 60 Hz.</p>
Permissible ambient temperatur*	<p>-20 °C to 40 °C or -20 °C to 55 °C</p> <p>The maximum ambient temperature specified on the type plate must not be exceeded.</p> <p>These values are valid for operation with an ON-period of 100%. For the following operation modes special requirements apply:</p> <ul style="list-style-type: none"> • cycled operation or • frequency-controlled operation or • synchronous operation. <p>These must be clarified with NetterVibration in individual cases.</p>
Protection classes	<ul style="list-style-type: none"> • Insulation class F • Temperature rise class B (except NEG 501540, 501800, 503400, 503820 and 508830)
Thermal overload protection	<p>From housing size 170 upwards with thermistor type PTC 130 °C as standard. For smaller vibrators available on request as initial equipment.</p> <p> If the NEA/NEG is operated in environments with potentially explosive dust (zone 21/22), it is mandatory to connect the PTC-thermistor. This regulation does not apply if the unit is not equipped with a PTC-thermistor.</p>
Sound level	<p>Depending on type ≤ 70 dB(A)</p> <p>The sound level is determined to a great extent by the surface upon which the NEA/NEG is mounted (e.g. sheet metal). The sound level will be amplified by non-silenced sheet metal.</p>

* Higher temperatures are only possible after consultation with and written approval from the application technicians of **NetterVibration**.

**Type plate
CIN / NEA
from housing
size 100**

NetterVibration  Germany, 55252 Mainz-Kastel, Tel. +49 6134 2901-0			
1 Type	CE EN 60034-1 UK CA	Duty 100%	14
2 U V		Fc N	13
3 I A		n min ⁻¹ f Hz	12
4 Ph Cap. μF		P _{in} kW	11
5 cos φ		P _{out} kW	10
6 Year		Ins.Cl.F Prot. IP 66	9
7 No.		Max. Amb. °C	8



- 1 Type designation
- 2 Nominal voltage
- 3 Current
- 4 Phases / capacity
- 5 Power factor
- 6 Year of manufacture
- 7 Serial number
- 8 Max. ambient temperature
- 9 Insulation class / degree of protection
- 10 Power output
- 11 Power input
- 12 Rotary speed / nominal frequency
- 13 Centrifugal force
- 14 Duty cycle

**Type plate
NEG S / NES**

NetterVibration  Germany, 55252 Mainz-Kastel, Tel. +49 6134 2901-0			
1 Type	CE EN 60034-1 UK CA	Duty 100 %	14
2 n min ⁻¹		Fc N	13
3 U V		f Hz	12
4 I A		P _{in} kW	11
5 Ph Cap. μF		P _{out} kW	10
6 No.		cos φ	9
7 Year		Ins.Cl.F Prot.	8

- 1 Type designation
- 2 Rotary speed
- 3 Nominal voltage
- 4 Current
- 5 Phases / capacity
- 6 Serial number
- 7 Year of manufacture
- 8 Insulation class / degree of protection
NEG S: IP66; NES: IP69K
- 9 Power factor
- 10 Power output
- 11 Power input
- 12 Nominal frequency
- 13 Centrifugal force
- 14 Duty cycle

**Type plate for
housing sizes
50 and 60**

NetterVibration  Germany, 55252 Mainz-Kastel, Tel. +49 6134 2901-0			
 II 3D Ex tc IIIC T100°C Dc			
1 Type	CE EN 60034-1 UK CA	Duty 100 %	14
2 U V		Fc N	13
3 I A		n min ⁻¹	12
4 Ph		f Hz	11
5 Year		P kW	10
6 No.		Ins.Cl. F Prot. IP65	9
7 Doc. No. NV 2017 002 X		T _{Amb.max.} °C	8

- 1 Type designation
- 2 Nominal voltage
- 3 Current
- 4 Phases
- 5 Year of manufacture
- 6 Serial number
- 7 Document number
- 8 Max. ambient temperature
- 9 Insulation class / degree of protection
- 10 Power
- 11 Nominal frequency
- 12 Rotary speed
- 13 Centrifugal force
- 14 Duty cycle
- 15  ATEX certification

Type plate from housing size 100

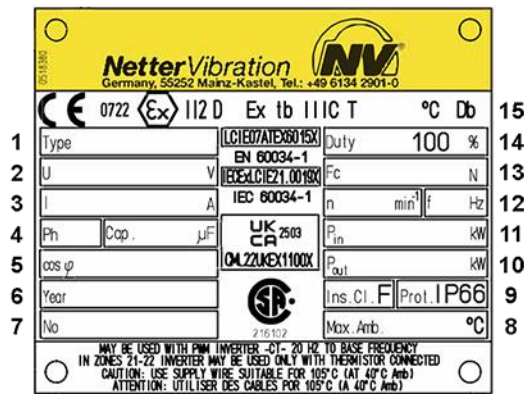

- 1 Type designation
- 2 Nominal voltage
- 3 Current
- 4 Phases / capacity
- 5 Power factor
- 6 Year of manufacture
- 7 Serial number
- 8 Max. ambient temperature
- 9 Insulation class / degree of protection
- 10 Power output
- 11 Power input
- 12 Rotary speed / nominal frequency
- 13 Centrifugal force
- 14 Duty cycle
- 15  ATEX certification

The values can be found on the type plate. The type plate is located on the housing.

For detailed technical data please refer to the brochure of the NEA/NEG. Deviating customer-specific type plates (special designs) are possible.

Tightening torques

NetterVibration recommends the following tightening torques [Nm]:

Type	M4	M5	M6	M8	M10	M12	M16	M20	M22	M24	M36	M42
Fastening screws and nuts, steel Property class 8.8*	-	-	10	25	50	87	210	411	559	711	2500	4000
Fastening screws for XS-unbalances, steel Property class 12.9**	-	-	-	42	83	146	360	710	970	1225	4200	6700
Fastening screws and nuts, stainless steel	-	-	8.8	21.4	44	74	183	-	-	-	-	-
Terminal plate nuts, steel	1.2	2.0	3.0	6.5	13.5	-	-	-	-	-	-	-

* coefficient of sliding friction 0.14 ** coefficient of sliding friction 0.15
 Screws as supplied, without additional lubrication.
 Always use a torque wrench and tighten the screws crosswise.

Type	M13x1	M15x1	M20x1	M25x1.5	M30x2	M45x1.5
Locking nuts (Pos. 21) see page 31	30	50	100	170	340	500

4 Design and function

Design

Example: NEG 501140

Example: NEG 50120

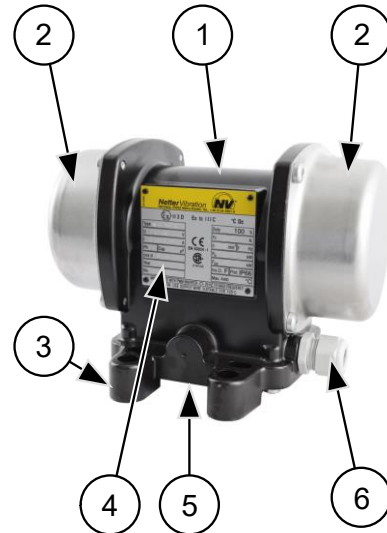
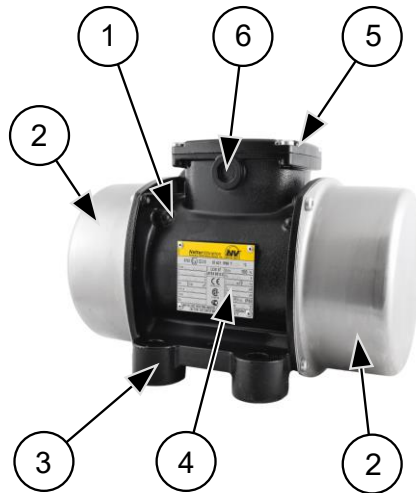

No.	Element	Function
1	Housing	Contains and protects the components of the NEA/NEG.
2	Unbalance covers	Protect against grabbing into the unbalances.
3	Housing foot	Attach the NEA/NEG to the mounting surface.
4	Type plate	Shows model specific information and data.
5	Terminal box Housing sizes 101 to 120: Terminal box integrated in housing foot	Contains the electrical connections.
6	Cable gland (depending on type)	Connect the NEA/NEG.

Function

The electric external vibrators of the series NEA, NEG, NEG S, NES and CIN are asynchronous motors with adjustable weights (unbalances) mounted on their shaft ends.

The NEA/NEG generate circular vibrations, that means the vibrations act in all directions of a plane.

The frequency can be controlled continuously with the help of frequency converters.

The centrifugal force can be changed by adjustment of the unbalances.

5 Transport and storage



Observe the safety instructions in chap. Safety, starting on page 6.

Weights and dimensions can be found in the NEA/NEG brochure.

Transport conditions

When transporting the NEA/NEG, ensure that the NEA/NEG is not subjected to strong impacts or vibrations that could damage the bearings.

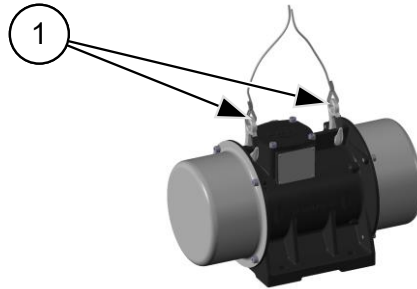

Please observe the following notes:

- Use only the transport eyelet (1) for lifting the NEA/NEG. If the vibrator is fitted with two transport eyelets, both must be used for lifting.
- The pulling direction must not exceed 45°.
- Lifting tools are of the usual kind such as a pulley or a crane. When moving loads, use suitable steel cables or hoisting slings which are sufficiently dimensioned for these weights.
- Handle the NEA/NEG very carefully during transport.

Packaging

The NEA/NEG are packed ready for installation.

The packaging protects the NEA/NEG from transport damage. The packaging material has been selected from an environmentally safe and technically disposable point of view and is therefore recyclable.

The return of packaging to the material cycle conserves raw materials and reduces the amount of waste.

Storage

- Store the NEA/NEG in a dry and clean environment.
- The permissible storage temperature is between +5 °C and +40 °C.
- The permissible relative humidity is max. 60%.
- After a storage period of 2 years, a revision at **NetterVibration** is mandatory.
-  If the vibrator is operated in ATEX areas a revision at **NetterVibration** is mandatory after a storage period of more than one year.
- Do not store the NEA/NEG outdoors. The electrical components are not protected against corrosion.

6 Installation



Observe the safety instructions in chap. Safety, starting on page 6.

Weights and dimensions can be found in the NEA/NEG brochure.

Fastening the NEA/NEG

Important: For NEA/NEG with housing size 101 to 120 the terminal box is integrated in the housing foot. These vibrators must be electrically connected before fastening.

The NEA/NEG can be operated in any position.

1. **Notice:** The feet of the NEA/NEG must lie completely on the surface so that there is no tension in the housing when tightening the fastening screw/screws, which could cause mechanical damage. The mounting surface has to be flat (± 0.1 mm flatness) and clean with no paint residues or burn-ins.



2. The vibrators can be fastened with fastening screws of quality 8.8 (DIN 931 or 933). These must be secured with appropriate locking devices and checked and retightened at regular intervals (usually monthly). For safe fastening **NetterVibration** recommends the use of fastening kits NBS consisting of a screw, a special lock washer and (for NBS D) a nut.

Fasten the NEA/NEG to the mounting surface with at least four fastening screws, or six or eight screws depending on the housing foot. Use a torque wrench and tighten the screws crosswise. Observe the recommended values for screw sizes and tightening torques, see chap. Technical data, from page 12. Higher tightening torques may cause fracture of screws or tearing of threads.

⚠ Warning: Incorrect assembly and screw connections may cause loosening of the NEA/NEG by vibration and seriously injure persons and damage material. A spark produced on impact can lead to the ignition of an explosive atmosphere.

3. Use an additional safety device for critical installation situations, e.g. steel cable NSE. Use the wire cable clamps to set the safety cable to the shortest possible cable length. The safety cable must always be tensioned.



Electrical connection

 The following requirements and conditions must be met to connect the NEA/NEG electrically:

- The permissible operating conditions must be met. Please refer to chap. Technical data, page 12 for operating conditions.

- A suitable overload protection (1) must be pre-connected to each vibrator. The motor protection switches must be interlocked with each other in pairs, so that in the event of a motor failure, the power supply from both motors is interrupted at the same time in order not to cause uncontrolled vibrations which can damage the system. In zone 21/22 the motor protection switches must be approved for applications in potentially explosive areas.

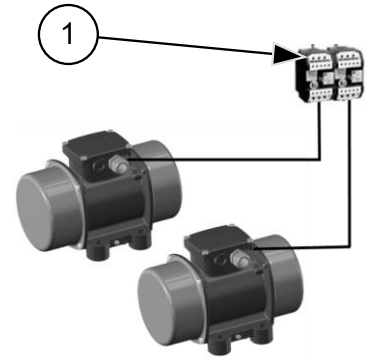

- If the vibrator is operated in areas with potentially explosive dust (zone 21/22), it is compulsory to connect the PTC-thermistor. This regulation does not apply for NEA/NEG without a PTC-thermistor.

- In areas with potentially explosive dust (zone 21/22), an external grounding must also be made via the earth connection on the housing foot.

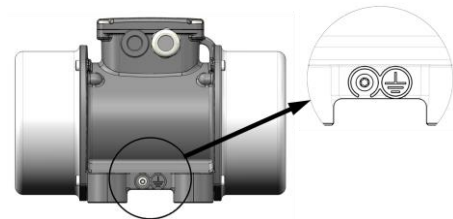

- Only suitable, flexible supply cables must be used for connecting the NEA/NEG. The conductors in the supply cable for the connection of the NEA/NEG to the mains must be temperature-resistant and have a sufficiently large cross-section, which is adapted to the cable length used. The temperature resistance of the cables depends on the maximum surface temperature (temperature class T, see section Special conditions, page 11) stated on the type plate. When selecting the connection cables, consider that the cables are mechanically stressed by vibration. Recommended cable types for mains operation at 400 V, in potentially non-explosive atmosphere: rubber hose line H07 RN-F or oil flex cable 110 CY. For other voltages or other ambient conditions, the cables must be adapted to the respective conditions and designed accordingly.
- All electrical cables must be carefully laid and must be protected from high temperatures, lubricants and sharp edges. Care must be taken to ensure that the cables are not chafed through by vibrating parts. The correct condition of the electrical cables with their plugs must be checked at regular intervals (usually every six months). Detected errors are to be eliminated immediately.
- The cable fastening must be provided in close vicinity of the cable entrance.

- The electrical parameters U, I, P on the type plate must be observed.
- Tighten terminal plate nuts with pre-scribed torque, see chap. Technical data, from page 12. Remember to put the safety washer between the ring and the nut and the vibration-damping insert back.

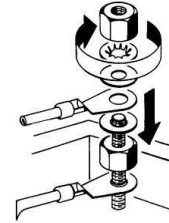

- The wire ends must be fitted with suitable insulated cable lugs, in order to prevent the strands from splaying.



- For operating the NEA/NEG in areas with potentially explosive dust (housing size 50 and 60: zone 21; from housing size 100: zone 21 und 22) the mechanical protection of the housing must be guaranteed (housing size 50 and 60: degree of protection IP65; from housing size 100: degree of protection IP66). After having disassembled the terminal box cover or weight covers, the condition and correct positioning of the seals has to be checked.

Connection examples NEG

Open the terminal box to connect the NEG according to the type plate as follows:

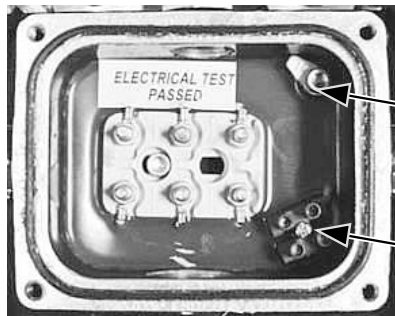

- 1 Earthing terminal for protective conductor (green-yellow)
- 2 PTC-Thermistor connection (optional, depending on the NEG type)

Connect the NEG according to the type plate and the following circuit diagrams.

The green-yellow protective conductor must only be connected to the earthing terminal.

Connection diagram

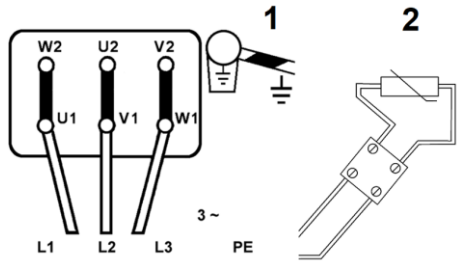
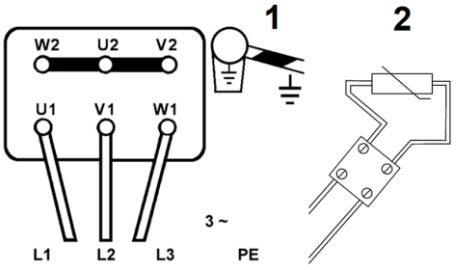
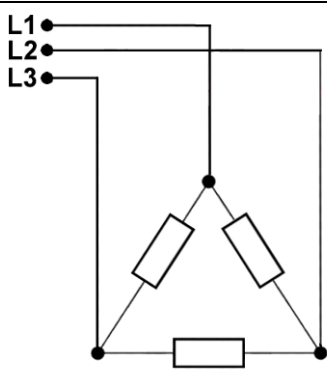
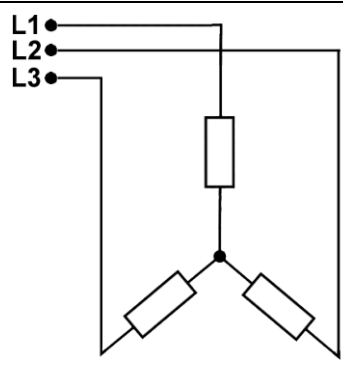
Series NEG / 3-phase current	
Smaller voltage	Higher voltage
	
<p>1: Earthing terminal for protective conductor 2: PTC-Thermistor connection (optional, depending on the NEG type)</p>	<p>1: Earthing terminal for protective conductor 2: PTC-Thermistor connection (optional, depending on the NEG type)</p>
	

Connection examples NEA

Connect the NEA according to the information on the type plate. Excluded from this is the NEA 504 operated without a capacitor.

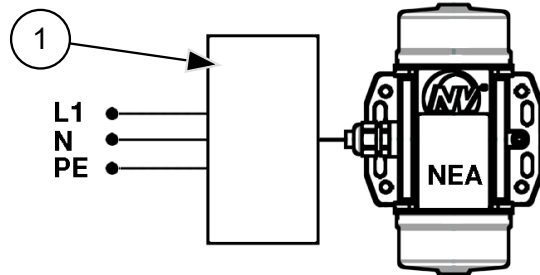

- 1 capacitor box
- L1 outer conductor (brown)
- N neutral conductor (blue)
- PE protective conductor (green-yellow)

Cable with capacitor box



Capacitor in cable



7 Start-up and operation



Observe the safety instructions in chap. Safety, starting on page 6.

Permissible operating conditions

Please refer to chap. Technical data, page 12 for permissible operating conditions.

Regulations

- When commissioning the NEA/NEG, the rules and regulations of the local associations for electrical engineering (e.g. VDE) and the valid accident prevention regulations must be observed.
- The NEA/NEG must always be switched on and off at the main switch.
- The NEA/NEG must not be operated without the covers for the unbalances. The rotating unbalances cause a risk of injury.
- On initial start-up, the current consumption must be measured individually in all three phases and must correspond to the specifications on the type plate.
- The terminal box cover must never be opened in the presence of voltage.

 **Special regulations for operation in an potentially explosive atmosphere:**

- The terminal box cover must never be opened in a potentially explosive atmosphere.
- NEA/NEG may only be operated in atmospheres that do not damage the material of the vibrators.

Measures

Carry out the following measures before start-up:

1. Check that the NEA/NEG have been mounted correctly and are in perfect condition.
2. Check that the NEA/NEG have been properly connected and earthed.
3. Check that the cables are undamaged and laid according to the known regulations and standards.
4. Check that all permissible operating conditions have been observed.
5. Check that all protective measures on the system have been observed.
6. Eliminate possible errors before start-up.
7. Screw connections must be checked and, if necessary, retightened after 1 h operating time (after initial start-up) and thereafter regularly (generally monthly). Observe the recommended values for screw sizes and tightening torques, see chap. Technical data, starting on page 12.

Power supply Standard network forms are TN and TT networks with an earthed star point, as in Germany.
 For overseas countries, also for countries within the EU, the mains voltage, the network configuration and the directives applicable there must also be observed. In the case of deviations, the country, the standards, the environmental conditions, as well as possible special features in the order, must be agreed on in writing. If the NEA/NEG are operated and/or powered by another network configuration unknown to us, the guarantee expires completely and immediately.

Supply line connection The supply line must be protected according to the cross-section and the nominal power of the NEA/NEG. The short circuit strength of this fuse should be 25 kA.

NetterVibration recommends a three-phase tripping (e. g. Schneider Electric GV2 L, Tesys Model U oder Compact NS).

Operating with frequency converter When operating the NEA/NEG with a frequency converter, compliance with the EMC directive (EMC regulations in UK) must be ensured.
 If the speed is controlled with a frequency converter, the maximum centrifugal force (according to the type plate) must not be exceeded.
 NEA/NEG must be adapted to your application by adjusting the unbalances. You can directly influence the vibration amplitude, centrifugal force and current consumption.

Vibrator series	Vibrator speed	Output frequency inverter	Unbalance adjustment
NEG 50... (2-pole)	up to 3000 min ⁻¹ *	up to 50 Hz	max. 100%
	up to 4200 min ⁻¹	up to 70 Hz	max. 50%
	up to 6000 min ⁻¹	up to 100 Hz	max. 25%
NEG 25... (4-pole)	up to 1500 min ⁻¹ *	up to 50 Hz	max. 100%
	up to 2100 min ⁻¹	up to 70 Hz	max. 50%
	up to 3000 min ⁻¹	up to 100 Hz	max. 25%
NEG 16... (6-pole)	up to 1000 min ⁻¹ *	up to 50 Hz	max. 100%
	up to 1400 min ⁻¹	up to 70 Hz	max. 50%
	up to 2000 min ⁻¹	up to 100 Hz	max. 25%
* Nominal speed			

 **Special regulations for operation in an potentially explosive atmosphere:**

- In ATEX-zones 21 and 22, the frequency converter may control the frequency between 20 Hz and 50 Hz or 20 Hz and 60 Hz at constant torque (linear Volt-Hertz curve). Observe maximum frequency on the type plate.
- For operation with frequency converter in ATEX-zones the PTC thermistor must be connected.

Adjustment of unbalances

For all NEA/NEG there is the possibility of unbalance adjustment to directly influence vibration amplitude, centrifugal force and current consumption.

Unless otherwise specified by you, the NEA/NEG were delivered with the standard setting (100%). If specifications have been made by the customer, there are stickers with the current setting on the unbalance covers.

Notice: The unbalances may only be set mirror-symmetrically!

**Procedure:**

1. Switch off the NEA/NEG at the main switch, secure against unintentional starting and ensure that there is no voltage.
2. Loosen both unbalance covers.
3. Loosen the locking nuts or locking screws.
4. Bring the unbalances to the desired setting according to the following descriptions for the various unbalance discs. Note the mirror-symmetrical setting.
5. Retighten the locking nuts or locking screws. Observe the recommended tightening torques, see chap. Technical data, starting on page 12.
6. Fasten both unbalance covers.

Number of unbalances

The tables below show the type of unbalance and the number of unbalances per vibrator at the default setting of 100%:

Type: NEA/NEG	Unbalance			Type: NEA/NEG	Unbalance		
	Type	Quantity			Type	Quantity	
		50 Hz	60 Hz			50 Hz	60 Hz
504	XL	8	8	258260	XS	4	4
5020	XL	8	8	2511210	XS	4	4
5050	XL	18	18	2513850	XS	4	4
5060	XLs	4	4	1630	XLs	8	8
50120	XLs	6	6	1690	XS	4	4
50200	XLs	10	8	16190	XS	4	4
50300	XLs	8	6	16310	XS	4	4
50550	XLs	10	6	16410	XS	4	4
50770	XLs	8	6	16500	XS	4	4
501140	XLs	12	8	16810	XS	4	4
501540	XLs	12	8	161130	XS	4	4
501800	XLs	14	10	161420	XS	4	4
502020	XLs	16	10	161610	XS	4	4
502270	XLs	18	12	162110	XS	4	4
503400	XLs	12	8	162550	XS	4	4
503820	XLs	14	10	163030	XS	4	4
506220	XS	4	4	163820	XS	4	4
508830	XS	4	4	164700	XS	4	4
2530	XLs	6	6	165190	XS	4	4
2570	XLs	16	10	166270	XS	4	4
25210	XS	4	4	166670	XS	4	4
25420	XS	4	4	167890	XS	4	4
25540	XS	4	4	168500	XS	4	4
25700	XS	4	4	169510	XS	4	4
25930	XS	4	4	1612060	XS	4	4
251410	XS	4	4	1613890	XS	4	4
251800	XS	4	4	1617000	XS	4	4
252060	XS	4	4	12100	XS	4	4
252370	XS	4	4	12180	XS	4	4
253050	XS	4	4	12230	XS	4	4
253720	XS	4	4	12460	XS	4	4
254310	XS	4	4	12640	XS	4	4
254900	XS	4	4	12900	XS	4	4
256460	XS	4	4	121430	XS	4	4
258040	XS	4	4	122150	XS	4	4

Type: NEA/NEG	Unbalance			Type: NEA/NEG	Unbalance		
	Type	Quantity			Type	Quantity	
		50 Hz	60 Hz			50 Hz	60 Hz
122640	XS	4	4	128520	XS	4	4
122920	XS	4	4	1211070	XS	4	4
123530	XS	4	4	1213160	XS	4	4
124440	XS	4	4	1217670	XS	4	4
127640	XS	4	4				

Unbalance discs type XL

The centrifugal force is adjustable with the unbalance discs (lamella) of type XL in the following steps:

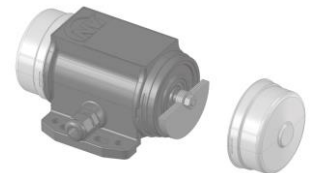
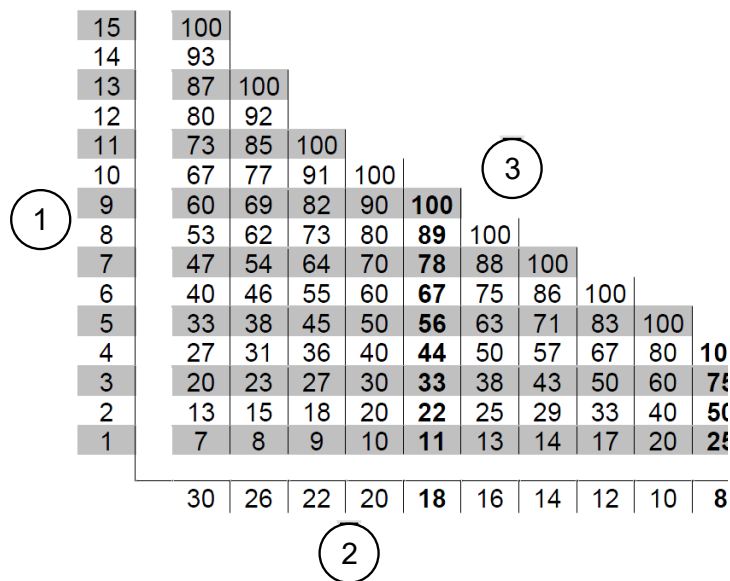

- 1: Number of unbalance discs per side
- 2: Default number of unbalance discs per vibrator
- 3: Centrifugal force in %

There are 2 possibilities to adjust the unbalances:

1. The unbalance adjustment (fine adjustment) is carried out by removing one unbalance disc on each side. All centrifugal values in % can be adjusted as specified in the table. The removed unbalance discs must be replaced by compensation washers of identical thickness and identical inner diameter. These are available from **NetterVibration**.
2. The unbalance adjustment (coarse adjustment) is performed by turning one unbalance disc on each side by 180° on the shaft. Twice the number of unbalance discs turned by 180° becomes ineffective.

Unbalances type XLs

The centrifugal force is adjustable with the unbalance discs (lamella) type XLs. Adjustment of the unbalances is carried out according to a scale disc or the supplementary sheet in the terminal box of the NEA/NEG.

By rotating the outer, adjustable unbalance disc(s) to another position, the percentage of the centrifugal force changes as shown in the illustration below. The grid position is defined by position pins.

Settings:

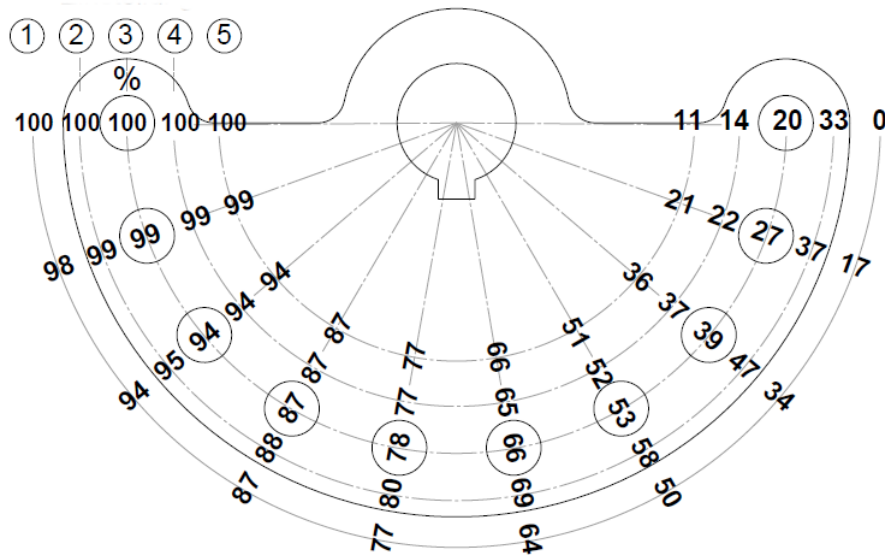

Set-tings	Unbalance per side		Type				50 Hz	60 Hz
	fixed	adjust-able						
1	1	1	NEG/NEA 5060				X	X
	2	2	NEG/NEA 50200	NEG 501140	NEG 501540	NEG 503400		X
			NEG 1630				X	X
			NEG/NEA 50300	NEG/NEA 50770			X	
	3	3	NEG 501140	NEG 501540	NEG 503400		X	
NEG 502270							X	
4	4	NEG/NEA 2570	NEG 502020			X		
2	2	1	NEG/NEA 50120	NEG/NEA 2530			X	X
2	2	1	NEG/NEA 50300	NEG/NEA 50770				X
2	2	1	NEG/NEA 50550					X
3	3	2	NEG/NEA 50200	NEG/NEA 50550			X	
3	3	2	NEG/NEA 2570	NEG 501800	NEG 502020	NEG 503820		X
4	4	3	NEG 501800	NEG 503820			X	
5	5	4	NEG 502270				X	

Example:

NEG 50120 / 50 Hz has a total of 6 unbalance discs (3 discs per side: 2 fixed, 1 adjustable).

If a centrifugal force of 88% is desired, the adjustable unbalance discs are rotated anticlockwise on both sides into the fourth grid position.

centrifugal force 100%



centrifugal force 88%



Unbalances type XS

The unbalance discs type XS consist of one fixed and one loose unbalance disc per side. The unbalance is adjusted according to the scales on the fixed unbalance discs.

After loosening the fixing screws, the centrifugal force can be adjusted continuously by turning the loose unbalance discs. After adjusting the unbalances, the nuts and screws must be tightened with the specified torque. Observe the recommended values for screw sizes and tightening torques in chap. Technical data, starting on page 12.



The centrifugal force can be adjusted according to the following table:

Adjustment (scale)	Centrifugal force in %	Adjustment (scale)	Centrifugal force in %
0°	100	105°	60
15°	98.5	120°	50
30°	97	135°	37.5
45°	92	150°	25
60°	87	165°	12.5
75°	78.5	180°	0
90°	70		

8 Maintenance and servicing



Observe the safety instructions in chap. Safety, starting on page 6.

Technical data

Information regarding tightening torques for screws and nuts can be found in chap. Technical data, starting on page 12.

Expertise and regulations

Maintenance and servicing of the vibrators may only be performed by regularly trained, authorised and qualified personnel. Work on the electrical system may only be carried out by a qualified electrician.

The qualified personnel has to work exclusively with tools suitable for the application.

In the case of unauthorised intervention in the NEA/NEG there is no longer any warranty claim.

Before all maintenance and servicing work the NEA/NEG must be safely disconnected from the electrical mains. The procedure is as follows:

1. Switch off NEA/NEG.
2. Secure against unintentional switching on.
3. Determine that NEA/NEG are voltage free.
4. Earth and short-circuit.
5. Cover and fence off neighbouring live parts.

 Interventions in the NEA/NEG, such as lubricating/changing of bearings or opening the terminal box, must not be performed in potentially explosive atmospheres.

 When operating in a potentially explosive dust atmosphere, the operator must regularly check the condition of the bearings and the duration of operation of the vibrators. Damaged bearings or bearings whose service life has been reached, must be replaced immediately. Alternatively, the vibrators can also be sent to **NetterVibration** for replacement of the bearings.

Maintenance plan

 Maintenance of the NEA/NEG must be carried out as follows:

Interval	Action
If required (depending on operating conditions)	Clean the NEA/NEG regularly with a wet cloth to remove dust deposits.
After one hour operation after initial start-up	Check screw connections and retighten if necessary.
Every 1000 operating hours	NEA/NEG with roller bearing, with speeds from 3000 min ⁻¹ : replace the grease of the bearings completely, with grease of the type KLUEBER Isoflex NBU 15.
Every 5000 operating hours	NEA/NEG with roller bearing, with speeds up to 2999 min ⁻¹ : replace the grease of the bearings completely, with grease of the type KLUEBER Staburags NBU 8.

Interval	Action
Monthly	Check screw connections and retighten if necessary.
	Check bearings and replace the grease if necessary, see section "lubrication". Damaged bearings or bearings whose service life has been reached, must be replaced immediately.
	Check cable supply line.
Every 6 month	Check proper condition of connecting cables and plugs.
Every 2 years	Replace O-rings and plastic seals.
At least every 4 years	Check proper condition of electrical systems and stationary electrical equipment.

Other maintenance and repair work are to be carried out exclusively by **NetterVibration**.

Notes on lubrication

Bearing type*	Lubrication
Ball bearings	Lubricated for their service life (permanent lubrication).
Roller bearings	Speeds up to 2999 min ⁻¹ , lubrication with: KLUEBER STABURAGS NBU 8 EP for min. 5000 operating hours.
	Speeds above 3000 min ⁻¹ , lubrication with: KLUEBER ISOFLEX NBU 15 for min. 1000 operating hours.

* For the bearing life, see the following table on lubrication of the NEA/NEG, starting on page 30.

After reaching the specified operating hours, the grease of the bearings must be completely replaced.

The lubrication intervals and bearing life must be considerably shortened under more difficult operating conditions.

**Lubrication /
bearing life
NEA/NEG**

Type of lubrication or grease quantity of the bearings and calculated bearing life of the NEA/NEG:

Type NEA/NEG	Lubrication/ grease quantity [g]	Bearing life [h] 50 Hz	Bearing life [h] 60 Hz	Type NEA/NEG	Lubrication/ grease quantity [g]	Bearing life[h] 50 Hz	Bearing life [h] 60 Hz
504	PL*	> 100,000	> 100,000	254310	40	12,800	11,820
5020	PL*	> 100,000	> 100,000	254900	40	16,540	14,240
5050	PL*	26,420	7,380	256460	80	17,110	14,110
5060	PL*	> 100,000	45,770	258040	80	15,050	12,610
50120	PL*	20,480	5,720	258260	180	85,260	13,020
50200	PL*	4,430	2,410	2511210	260	18,110	14,930
50300	PL*	3,690	3,470	2513850	300	8,950	6,180
50550	PL*	2,870	3,700	1630	PL*	> 100,000	> 100,000
50770	PL*	4,010	2,671	1690	PL*	> 100,000	> 100,000
501140	12	4,900	4,930	16190	PL*	> 100,000	76,640
501540	16	6,160	5,580	16310	PL*	> 100,000	> 100,000
501800	16	3,740	2,730	16410	12	> 100,000	> 100,000
502020	30	11,210	12,650	16810	PL*	9,320	5,530
502270	30	7,640	7,040	161130	PL*	18,160	14,280
503400	40	16,230	15,490	161420	PL*	9,130	6,390
503820	40	9,710	7,360	161610	30	13,560	13,440
506220	120	9,740	7,670	162110	PL*	5,970	5,170
508830	150	5,510	4,660	162550	32	29,540	24,420
2530	PL*	> 100,000	> 100,000	163030	32	61,800	44,960
2570	PL*	> 100,000	> 100,000	163820	60	21,050	7,140
25210	PL*	21,530	17,330	164700	80	28,490	24,580
25420	PL*	16,120	13,330	165190	80	28,610	23,710
25540	PL*	6,640	4,500	166270	120	24,460	23,590
25700	PL*	19,460	13,810	166670	120	23,180	23,570
25930	12	17,760	14,880	167890	150	24,080	20,490
251410	16	17,300	13,130	168500	150	18,790	15,630
251800	30	35,420	31,920	169510	180	17,670	18,080
252060	30	22,890	19,770	1612060	180	21,310	18,510
252370	35	27,190	21,740	1613890	300	22,110	19,090
253050	35	11,740	9,690	1617000	360	19,180	17,710
253720	40	20,730	18,040				

*PL = permanent lubrication

Type NEA/NEG	Lubrication/ grease quantity [g]	Bearing life [h] 50 Hz	Bearing life [h] 60 Hz	Type NEA/NEG	Lubrication/ grease quantity [g]	Bearing life [h] 50 Hz	Bearing life [h] 60 Hz
12100	PL*	> 100,000	> 100.000	122920	100	> 100,000	60,260
12180	PL*	> 100,000	> 100.000	123530	120	> 100,000	63,830
12230	12	> 100,000	> 100.000	124440	150	> 100,000	54,000
12460	PL*	70,870	20.620	127640	120	48,890	18,100
12640	PL*	> 100,000	41.570	128520	180	90,380	31,980
12900	PL*	> 100.000	28.350	1211070	260	62,760	25,270
121430	32	> 100,000	66.270	1213160	300	60,000	21,590
122150	60	> 100,000	47.680	1217670	360	36,760	15,260
122640	80	> 100,000	63.900				

*PL = permanent lubrication

Lubrication or replacement of bearings

The item numbers refer to the spare parts list.

NEG 16310

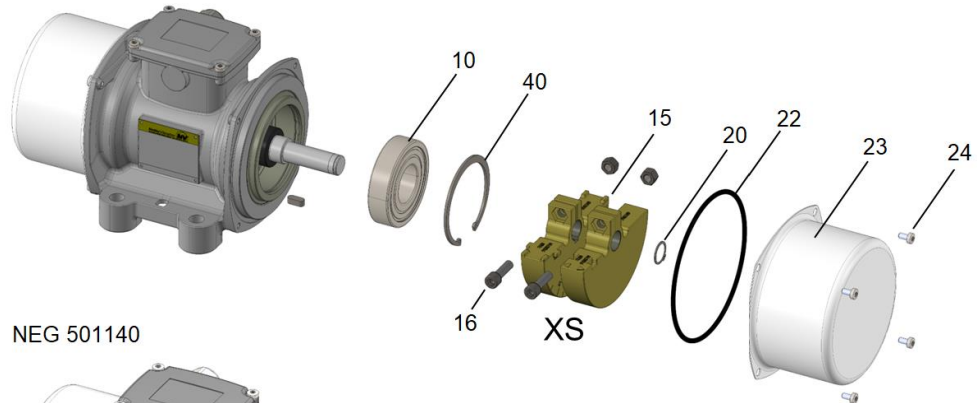

NEG 501140

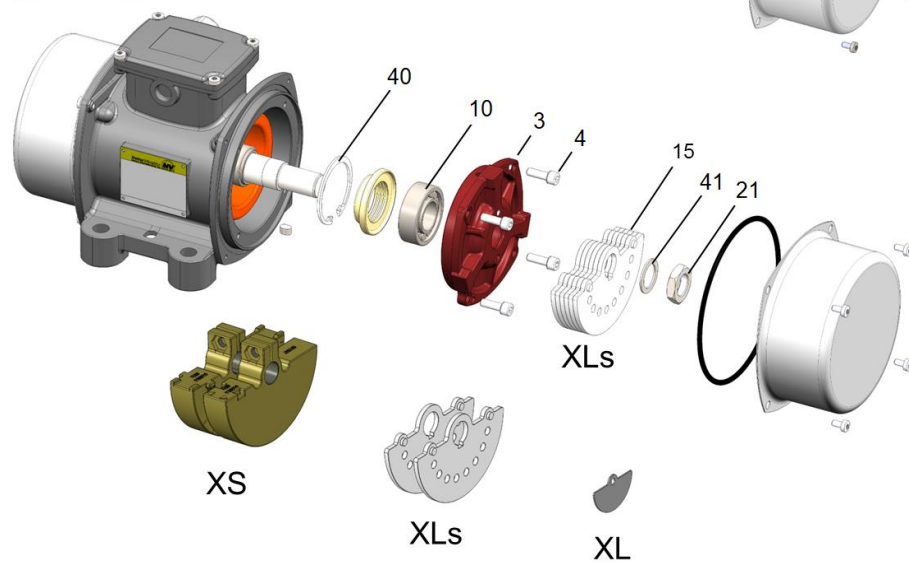

1. Switch off NEA/NEG, secure against switching on again and ensure that it is volt-free.
2. Loosen screw (24) and remove unbalance covers (23).

3. **Disassemble unbalances type XS:**

After removing the circlip (20) and loosening the clamping screws (16), the unbalances can be removed.

Disassemble unbalances type XL and type XLs:

Screw a long screw with the same thread into a tapped hole for the fastening screws (24) of the unbalance cover. Put a lever between the unbalance discs and this long screw. After loosening the locking nut (21), the unbalances can be removed from the shaft.

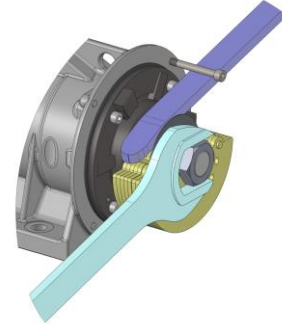

4. Remove bearing (10):
up to housing size 120: Remove circlip (40).
Starting from housing size 130: loosen screws (4) and remove flange (3). Remove circlip (40) from flange (3).
5. Replace both bearings (10) or remove old grease (e. g. with benzine) and smear the specified amount (see table) of new grease (according to the maintenance plan) evenly.
6. Assembly is carried out in the reverse order.
7. Tighten locking nuts (21) and screws (4, 16) to the specified tightening torque.

9 Troubleshooting



Observe the safety instructions in chap. Safety, starting on page 6.

Expertise and regulations

Troubleshooting of the vibrators may only be performed by regularly trained, authorised and qualified personnel. Work on the electrical system may only be carried out by a qualified electrician.

The qualified personnel has to work exclusively with tools suitable for the application.

In the case of unauthorised intervention in the NEA/NEG there is no longer any warranty claim.

Before any troubleshooting the NEA/NEG must be safely disconnected from the electrical mains. The procedure is as follows:

1. Switch off NEA/NEG.
2. Secure against unintentional switching on.
3. Determine that NEA/NEG are voltage free.
4. Earth and short-circuit.
5. Cover and fence off neighbouring live parts.

 Interventions in the NEA/NEG must not be performed in potentially explosive atmospheres.

Trouble-shooting

Fault	Possible cause	Corrective action
Vibrator does not start or runs at too low speed	Phase interruption	Check fuse and connection cable, replace, if necessary.
	Mains voltage too low	Check mains voltage and cable cross-section and, if necessary, adjust or replace cable.
Vibrator speed drops under load	Wiring wrong	Check circuit diagram.
	Inadequate contact of a connection point	Check connections in the terminal box, tighten terminal plate nuts.
	Phase interruption	Check fuse and connection cable, replace, if necessary.
	Incorrectly dimensioned connection cable	Check cable cross section and replace cable, if necessary.
	Overload	Check setting of unbalance, reduce unbalances.
Mains voltage too low	Check mains voltage and cable cross-section and, if necessary, adjust or replace cable.	

Fault	Possible cause	Corrective action
Excessive heating of the vibrator	Wiring wrong / overload	Check circuit diagram.
	Mains voltage too low	Check mains voltage and cable cross-section and, if necessary, adjust or replace cable.
	Too much grease in bearings	Fill in correct amount of grease.
	No grease or not enough grease in bearings	Fill in correct amount of grease.
	Worn bearing or foreign objects in the bearing	Clean bearings, replace if necessary.
Vibrator hums	Phase interruption	Check fuse, mains voltage and connection cable. Correct mains voltage, replace fuse and/or cable, if necessary.
	Short-circuit between turns in the stator winding	Replace vibrator.
Circuit breaker fails when switched on	Phase interruption	Check fuse and connection cable, replace, if necessary.
	Overload	Check unbalance settings, reduce unbalance.
	Short circuit in winding	Replace vibrator.
High current consumption	Natural resonance range of vibration system	Measure current consumption, stiffen device.
	Bounce impacts, cracks in steel construction	Measure current consumption, reduce power of vibrator.
Check steel structure for cracks, repair if necessary. Check fastening, tighten fastening screws, if necessary.		
Breakage of the housing foot	Tensions in the housing	Replace vibrator. Check the flatness of the mounting surface. Tighten the fastening screws to the appropriate torque.
	Loose fastening	Replace vibrator. Tighten the fastening screws according to the maintenance schedule.
	Mounting surface not flat	Replace vibrator. Clean the mounting surface, grind or mill flat.

10 Spare parts and accessories

Ordering of spare parts

Please provide the following details when ordering spare parts:

1. type designation according to the type plate
2. serial number according to the type plate
3. description and position number of spare part
4. required amount

Example NEG 50300

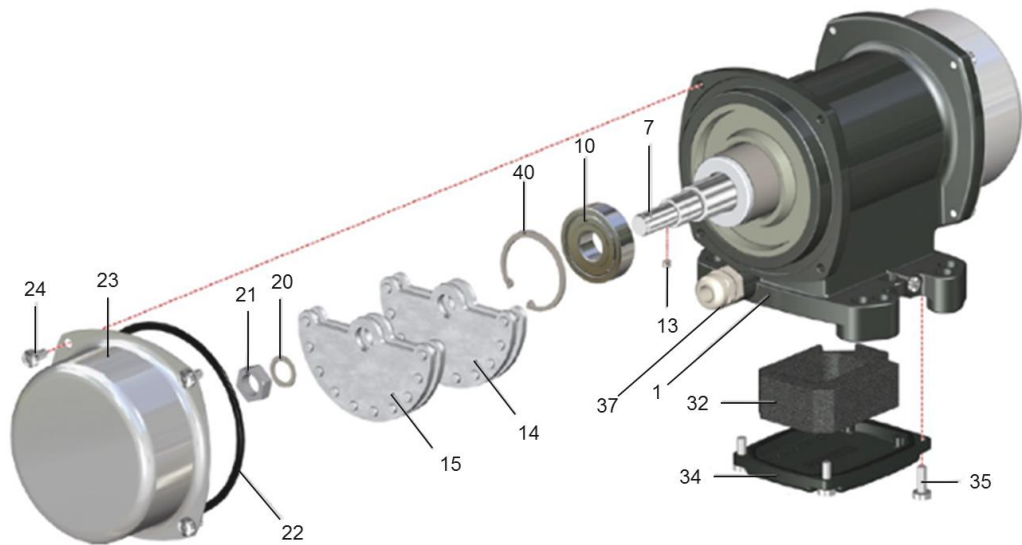

Example NEG 501140

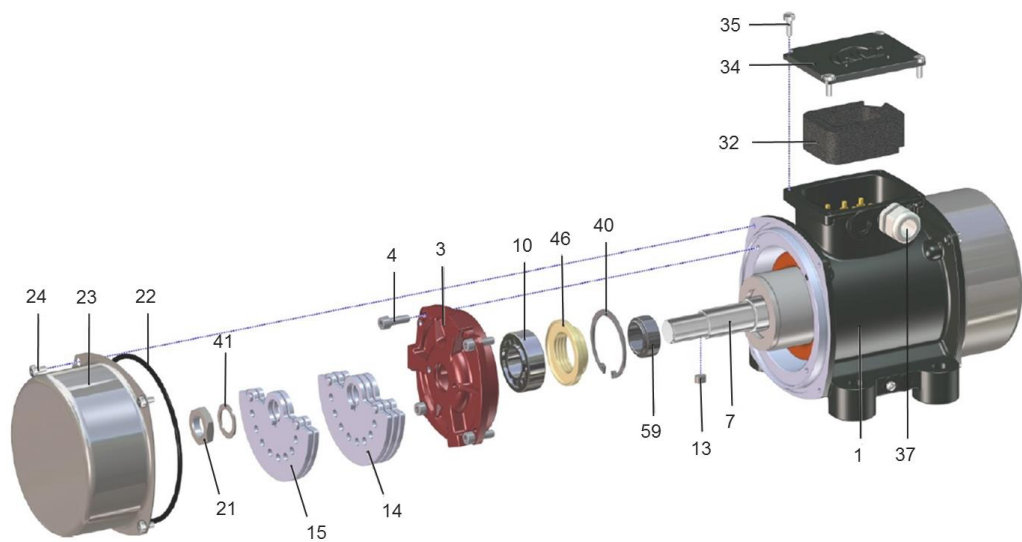

Accessories

The following accessories are available for NEA/NEG:

Component	Description
Shim washers	Compensation for removed unbalance discs.
CC-unbalances	Depending on the direction of rotation, two different unbalances can be achieved.
Fastening kits NBS	Recommended for secure and permanent fastening of the NEA/NEG.
Safety cables NSE	Prescribed in critical installation situations for additional protection against the NEA/NEG falling down.
Frequency converters	For frequency-controlled operation.
Brake accessories	Enable rapid deceleration of vibrators.
PTC thermistor	PTC 120 °C thermistor for safe operation of the vibrators.

Further electrotechnical accessories on request.



Special models

The following special models are available on request:

- Versions for special voltages,
- Stainless steel versions (NES/NEG S) for application in an aggressive atmosphere.

11 Disposal

Notes for disposal

 	<p>All parts of the NEA/NEG are to be collected separately and disposed of properly according to material specifications.</p> <p>The NEA/NEG must not be disposed of in household waste.</p> <p>The valid disposal prices of the NEA/NEG are available on request.</p>
--	--

Materials specifications

All parts of the NEA/NEG can be recycled.

Type: NEA

Material	Part
Stainless steel	Unbalance covers
Steel	Rotor, unbalances, flange, bearings, screws, washers, nuts
Aluminium	Housing, type plate
Plastic	Seals, terminal box block
Copper with resin	Winding

Type: NEG, CIN and stainless steel versions NES, NEG S

Material	Part		
	NEG and CIN housing types I, II and III	NEG housing type IV	NES and NEG S
Stainless steel	Unbalance covers		Housing, unbalance covers, terminal box block and cover, type plate
Steel	Housing size 140 and 160, rotor, unbalances, flange, bearings, screws, washers, nuts	Housing, rotor, unbalances, flange, bearings, screws, washers, nuts	Rotor, unbalances, flange, bearings, screws, washers, nuts
Aluminium	Housing, type plate, terminal box cover	Housing size 150 and 170 up to 210, unbalance covers, type plate, terminal box cover	–
Plastic	Seals, terminal box block	Seals, terminal box block	Seals
Copper with resin	Winding	Winding	Winding

12 Annex

NetterVibration

**Declaration of Conformity for
electric external vibrators series
NEA/NEG**

 Sept. 2023
No. 4910E

**Declaration of conformity in compliance with
ATEX Directive 2014/34/EU**

We herewith confirm that the electric external vibrators

series NEA/NEG

comply with the above directive.

Used harmonised standards:

EN IEC 60079-0:2018
EN 60079-31:2014
EN 60034-1:2010
Description:

The electric external vibrators series NEA/NEG consist of a rotor, a stator, roller bearings and opposing unbalances at both ends. The entire unit is integrated in a housing of aluminum alloy or cast iron. The types differ in size and the way they are fastened.

The sign X placed after the certificate number indicates that the equipment is subject to special conditions for safe use as specified in the annex of this declaration.

The marking of the electric external vibrators additionally includes:

 **II 3D Ex tc IIIC T100°C Dc** (housing size 50 and 60)

Documentation:
Doc. No. NV 2017 002 X (internal document number / GG 50 and 60)

Mainz-Kastel, 26.09.2023

 p.p. M. Herrmann
 (Chief Technical Officer)





NetterVibration



**Annex to the Declaration of
Conformity for
electric external vibrators series
NEA/NEG**

Sept. 2023
No. 4910E

Marking:

 Germany, 55252 Mainz-Kastel. Tel. +49 6134 2901-0	
 II 3D Ex tc IIIC T100°C Dc	
Type	Duty 100 %
U V	Fc N
I A	n min ⁻¹
Ph	f Hz
Year	P kW
No.	Ins.Cl. F Prot. IP65
Doc. No. NV 2017 002 X	T _{Amb. max.} °C

Special conditions for safe use:

- The cable attachment must be provided in the immediate vicinity of the cable entrance.
- The electrical parameters U, I, P indicated on the type plate must be adhered to.
- All accessories connected to the NEA/NEG that are designed to guarantee proper functioning and safety must have a degree of protection appropriate to the specific application.
- The operator must regularly check the good condition of the roller bearings and must never exceed the service life specified by the manufacturer.
- A PTC thermistor must be available and connected to operate the NEA/NEG with a frequency converter in ATEX zones.

Mainz-Kastel, 26.09.2023

p. p. M. Herrmann
(Chief Technical Officer)

Netter GmbH
Fritz-Lenges-Str. 3
55252 Mainz-Kastel

Germany • Switzerland • Poland • Spain • Australia • United Kingdom • France

www.NetterVibration.com

Serving industry with vibration

NetterVibration

**Declaration of Conformity for
Electric External Vibrators series
NEA/NEG**

 Sept. 2023
Nr. 4911E

**Declaration of conformity in compliance with
ATEX Directive 2014/34/EU**

We herewith confirm that the electric external vibrators

series NEA/NEG

comply with the above directive.

Used harmonised standards:

EN IEC 60079-0:2018

EN 60079-31:2014

EN 60034-1:2010

Description:

The Electric External Vibrators series NEA/NEG consist of a rotor, a stator, roller bearings and opposing unbalances at both ends. The entire unit is integrated in an housing of aluminium alloy or cast iron. The types differ in size and in the way they are fastened.

The sign X placed after the certificate number indicates that the equipment is subject to special conditions for safe use as specified in the annex of this declaration.

The marking of the electric external vibrators additionally includes:



II 2D Ex tb IIIC T120°C...T150°C Db

(from housing size 100 upwards)

Documentation:

LCIE 07 ATEX 6015 X - version 03

EC type examination

CESI 02 ATEX 065 Q

Product quality assurance notification

Mainz-Kastel, 26.09.2023

 p.p. M. Herrmann
 (Chief Technical Officer)

Netter GmbH
Fritz-Lenges-Str. 3
55252 Mainz-Kastel

Germany • Switzerland • Poland • Spain • Australia • United Kingdom • France

www.NetterVibration.com



NetterVibration



Annex to the Declaration of Conformity for Electric External Vibrators series NEA/NEG

Sept. 2023
No. 4911E

Markings:

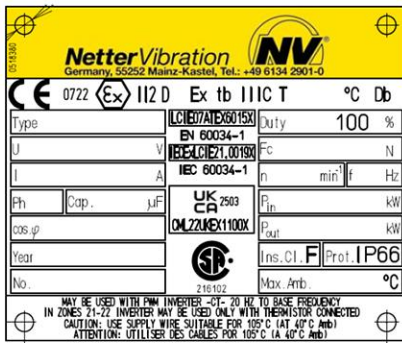

Special conditions for safe use:

- The electric vibrators may be used with an inverter, in which case the equipment shall be provided with temperature sensing on the motor windings which must not allow the temperature to exceed 130°C.
- A 130°C PTC thermistor is installed from housing size 170 included and up. The connection of this protection is mandatory for the user, this is indicated in the operating instructions.
- All safety devices shall operate independently of any measurement or control devices required for operation, and comply with the EN 50495. Resetting the safety devices shall only be manual.
- Ambient temperature range: -20°C ... +40°C or +55°C.
- The entries of the equipment shall be equipped with certified cable glands or blanking elements with compatible modes of protection for the intended use.
- Potential electrostatic charging hazard. Clean only with a wet cloth.
- The cables and the relevant accessories (e.g. cable glands) must be suitable for an operating temperature at least:
 - +85°C up to housing size 130 for an ambient temperature of +40°C (excepted the motors with 8 poles).
 - +90°C up to housing size 130 for an ambient temperature of +40°C (only the motors with 8 poles).
 - +100°C up to housing size 130 for an ambient temperature of +55°C.
 - +105°C for housing size 133 and up for an ambient temperature of +40°C.
 - +120°C for housing size 133 and up for an ambient temperature of +55°C.

Mainz-Kastel, 26.09.2023

p.p. M. Herrmann
(Chief Technical Officer)

Netter GmbH
Fritz-Lenges-Str. 3
55252 Mainz-Kastel

Germany • Switzerland • Poland • Spain • Australia • United Kingdom • France

www.NetterVibration.com

Serving industry with vibration



IECEX Certificate of Conformity
for NEA/NEG
IECEX LCIE 21.0019X

Sept. 2023
Nr. 4930E

**IECEX Certificate of Conformity for Electric External Vibrators
of the series NEA/NEG, from housing size 100**

This certificate is issued as verification that a sample(s), representative of production, was assessed and tested and found to comply with the IEC Standard list below and that the manufacturer's quality system, relating to the Ex products covered by this certificate, was assessed and found to comply with the IECEX Quality system requirements.

Description of the vibrators:

The electric external vibrators of the series NEA/NEG consist of a rotor, a stator, roller bearings and opposing unbalances at both ends. The entire unit is integrated in an housing of aluminium alloy or cast iron. The types differ in size and in the way they are fastened.

It has been noted that the NEA/NEG comply with the following standards:

IEC 60079-0:2017

IEC 60079-31:2013

Type of protection and marking:

Ex tb

Ex tb IIIC T120°C...165°C Db

IECEX certification number:

IECEX LCIE 21.0019X

Details of type designation:

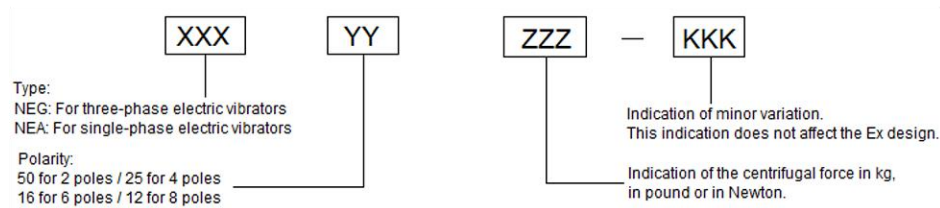

Mainz-Kastel, 28.09.2023

p.p. M. Herrmann
(Chief Technical Officer)

Netter GmbH
Fritz-Lenges-Str. 3
55252 Mainz-Kastel

Germany • Switzerland • Poland • Spain • Australia • United Kingdom • France

www.NetterVibration.com

Serving industry with vibration



NetterVibration

**Annex to the
IECEX Certificate of Conformity
for NEA/NEG
IECEX LCIE 21.0019X**

Sept. 2023
Nr. 4930E

Special conditions for safe use:

- The electric vibrators may be used with an inverter, in which case the equipment shall be provided with temperature sensing on the motor windings which must not allow the temperature to exceed 130°C.
- A 130°C PTC thermistor is installed from housing size 170 included and up. The connection of this protection is mandatory for the user, this is indicated in the operating instructions.
- All safety devices shall operate independently of any measurement or control devices required for operation, and comply with the EN 50495. Resetting the safety devices shall only be manual.
- Ambient temperature range: -20°C ... +40°C/+55°C.
- The entries of the equipment shall be equipped with certified cable glands or blanking elements with compatible modes of protection for the intended use.
- Potential electrostatic charging hazard. Clean only with a wet cloth.
- The cables and the relevant accessories (e.g. cable glands) must be suitable for an operating temperature at least:
 - +85°C up to housing size 130 for an ambient temperature of +40°C (excepted the motors with 8 poles).
 - +90°C up to housing size 130 for an ambient temperature of +40°C (only the motors with 8 poles).
 - +100°C up to housing size 130 for an ambient temperature of +55°C.
 - +105°C for housing size 133 and up for an ambient temperature of +40°C.
 - +120°C for housing size 133 and up for an ambient temperature of +55°C.

Markings:

NetterVibration	Ex tb IIIC T120°C...T165°C Db (1)	U: ... V (1)
Germany, 55252 Mainz-Kastel	Max. Amb.:+40°C or +55°C (1)(2)	P in: ... kW (1)
Serial number: ...	T Cable: ...°C (2)	I: ... A (1)
Year of construction: ...	IECEX LCIE 21.0019X	f: ... Hz (1)
Type: NEG... or NEA...		

(1) see type plate of the vibrator.

(2) see special conditions for safe use.

WARNING - DO NOT OPEN WHEN AN EXPLOSIVE ATMOSPHERE IS PRESENT.

WARNING - POTENTIAL ELECTROSTATIC CHARGING HAZARD: CLEAN ONLY WITH A WET CLOTH.

Mainz-Kastel, 28.09.2023



p.p.: M. Herrmann
(Chief Technical Officer)

Netter GmbH
Fritz-Lenges-Str. 3
55252 Mainz-Kastel

Germany • Switzerland • Poland • Spain • Australia • United Kingdom • France

www.NetterVibration.com



2503



NetterVibration



Declaration of Conformity
for NEA/NEG
CML 22UKEX1100X

Sept. 2023
No. 4931E

Declaration of Conformity
in compliance with

Equipment and Protective Systems Intended for use in Potentially Explosive Atmospheres
Regulations 2016, S.I. 2016:1107

We herewith confirm that the external electric vibrators

series NEA/NEG

comply with the above directive.

Used harmonised standards:

EN IEC 60079-0:2018

EN 60079-31:2014

Description:

The electric external vibrators of the series NEA/NEG consist of a rotor, a stator, roller bearings and opposing unbalances at both ends. The entire unit is integrated in a housing of aluminum alloy or cast iron. The types differ in size and the way they are fastened.

The sign X placed after the certificate number indicates that the equipment is subject to special conditions for safe use as specified in the annex of this declaration.

Certificate numbers:

UK Type Examination Certificate number: CML 22UKEX1100X

Approved body number: 2503

CE ATEX certificate number: LCIE 07 ATEX 6015 X, Issue 3

Mainz-Kastel, 28.09.2023

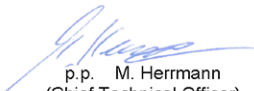
p.p. M. Herrmann
(Chief Technical Officer)

Netter GmbH
Fritz-Lenges-Str. 3
55252 Mainz-Kastel

Germany • Switzerland • Poland • Spain • Australia • United Kingdom • France

www.NetterVibration.com



2503



NetterVibration



**Annex to the Declaration of
Conformity for NEA/NEG
CML 22UKEX1100X**

Sept. 2023
No. 4931E

Special conditions for safe use:

- The electric vibrators may be used with an inverter, in which case the equipment shall be provided with temperature sensing on the motor windings which must not allow the temperature to exceed 130°C.
- A 130°C PTC thermistor is installed from housing size 170 included and up. The connection of this protection is mandatory for the user, this is indicated in the operating instructions.
- All safety devices shall operate independently of any measurement or control devices required for operation, and comply with the EN 50495. Resetting the safety devices shall only be manual.
- Ambient temperature range: -20°C ... +40°C/+55°C.
- The entries of the equipment shall be equipped with certified cable glands or blanking elements with compatible modes of protection for the intended use.
- Potential electrostatic charging hazard. Clean only with a wet cloth.
- The cables and the relevant accessories (e.g. cable glands) must be suitable for an operating temperature at least:
 - +85°C up to housing size 130 for an ambient temperature of +40°C (excepted the motors with 8 poles).
 - +90°C up to housing size 130 for an ambient temperature of +40°C (only the motors with 8 poles).
 - +100°C up to housing size 130 for an ambient temperature of +55°C.
 - +105°C for housing size 133 and up for an ambient temperature of +40°C.
 - +120°C for housing size 133 and up for an ambient temperature of +55°C.

Markings:

NetterVibration	 II 2 D	U: ... V (1)
Germany, 55252 Mainz-Kastel	Ex tb IIIC T120°C...T150°C Db (1)	P in: ... kW (1)
Serial number: ...	LCIE 07 ATEX 6015 X	I: ... A (1)
Year of construction: ...	Max. Amb.:+40°C or +55°C (1)(2)	f: ... Hz (1)
Type: NEG... or NEA...	T Cable: ...°C (1)(2)	(1) see type plate of the vibrator. (2) see indication in specific conditions of use.

WARNING - DO NOT OPEN WHEN AN EXPLOSIVE ATMOSPHERE IS PRESENT.

WARNING - POTENTIAL ELECTROSTATIC CHARGING HAZARD: CLEAN ONLY WITH A WHET CLOTH.

Mainz-Kastel, 28.09.2023

p.p. M. Herrmann
(Chief Technical Officer)

Netter GmbH
Fritz-Lenges-Str. 3
55252 Mainz-Kastel

Germany • Switzerland • Poland • Spain • Australia • United Kingdom • France

www.NetterVibration.com

Serving industry with vibration